

PRODUCT MONOGRAPH
INCLUDING PATIENT MEDICATION INFORMATION

^{Pr}SKYRIZI®

risankizumab injection

150 mg in 1 mL sterile solution (150 mg/mL) subcutaneous injection

360 mg in 2.4 mL sterile solution (150 mg/mL) subcutaneous injection

75 mg in 0.83 mL sterile solution (90 mg/mL) subcutaneous injection

risankizumab for injection

600 mg in 10 mL sterile solution (60 mg/mL) for intravenous infusion

Interleukin-23 (IL-23) inhibitor

AbbVie Corporation
8401 Trans-Canada Highway
St-Laurent, QC H4S 1Z1

Date of Initial Authorization:
APR 17, 2019

Date of Revision:
JAN 25, 2023

Submission Control Number: 267317

RECENT MAJOR LABEL CHANGES

1 INDICATIONS	10/2022
1 INDICATIONS, 1.1 Pediatrics	10/2022
1 INDICATIONS, 1.2 Geriatrics	10/2022
4 DOSAGE AND ADMINISTRATION	10/2022
4 DOSAGE AND ADMINISTRATION, 4.1 Dosing Considerations	10/2022
4 DOSAGE AND ADMINISTRATION, 4.2 Recommended Dose and Dosage Adjustments	10/2022
4 DOSAGE AND ADMINISTRATION, 4.3 Reconstitution	10/2022
4 DOSAGE AND ADMINISTRATION, 4.4 Administration	10/2022
6 DOSAGE FORMS, STRENGTHS, COMPOSITION AND PACKAGING	10/2022
7 WARNINGS AND PRECAUTIONS	10/2022
7 WARNINGS AND PRECAUTIONS, 7.1.1 Pregnant Women	10/2022
7 WARNINGS AND PRECAUTIONS, 7.1.3 Pediatrics	10/2022

TABLE OF CONTENTS

Sections or subsections that are not applicable at the time of authorization are not listed.

RECENT MAJOR LABEL CHANGES 2

TABLE OF CONTENTS 2

PART I: HEALTH PROFESSIONAL INFORMATION 5

1 INDICATIONS..... 5

 1.1 Pediatrics (< 18 years of age)..... 5

 1.2 Geriatrics (≥ 65 years of age)..... 5

2 CONTRAINDICATIONS..... 5

3 SERIOUS WARNINGS AND PRECAUTIONS BOX 5

4 DOSAGE AND ADMINISTRATION..... 6

 4.1 Dosing Considerations 6

 4.2 Recommended Dose and Dosage Adjustment 6

 4.3 Reconstitution..... 7

 4.4 Administration 8

 4.5 Missed Dose 8

5	OVERDOSAGE.....	9
6	DOSAGE FORMS, STRENGTHS, COMPOSITION AND PACKAGING	9
7	WARNINGS AND PRECAUTIONS.....	10
	7.1 Special Populations.....	11
	7.1.1 Pregnant Women.....	11
	7.1.2 Breast-feeding.....	12
	7.1.3 Pediatrics (< 18 years of age).....	12
	7.1.4 Geriatrics (≥ 65 years of age).....	12
8	ADVERSE REACTIONS.....	12
	8.1 Adverse Reaction Overview	12
	8.2 Clinical Trial Adverse Reactions	12
	8.3 Less Common Clinical Trial Adverse Reactions.....	16
	8.4 Post-Market Adverse Reactions.....	16
9	DRUG INTERACTIONS	17
	9.2 Drug Interactions Overview	17
	9.3 Drug-Behavioural Interactions.....	17
	9.4 Drug-Drug Interactions	17
	9.5 Drug-Food Interactions.....	17
	9.6 Drug-Herb Interactions	17
	9.7 Drug-Laboratory Test Interactions.....	18
10	CLINICAL PHARMACOLOGY.....	18
	10.1 Mechanism of Action	18
	10.2 Pharmacodynamics.....	18
	10.3 Pharmacokinetics.....	18
11	STORAGE, STABILITY AND DISPOSAL.....	20
12	SPECIAL HANDLING INSTRUCTIONS.....	21
	PART II: SCIENTIFIC INFORMATION	22
13	PHARMACEUTICAL INFORMATION	22
14	CLINICAL TRIALS	23
	14.1 Clinical Trials by Indication	23

15	MICROBIOLOGY	38
16	NON-CLINICAL TOXICOLOGY	39
	PATIENT MEDICATION INFORMATION	41
	PATIENT MEDICATION INFORMATION	47
	PATIENT MEDICATION INFORMATION	52
	Instructions for Use	57
	Instructions for Use	61
	Instructions for Use	65
	Instructions for Use	77

PART I: HEALTH PROFESSIONAL INFORMATION

1 INDICATIONS

Skyrizi (risankizumab injection) is indicated for:

- the treatment of adult patients with moderate to severe plaque psoriasis who are candidates for systemic therapy or phototherapy.
- the treatment of adult patients with active psoriatic arthritis. Skyrizi can be used alone or in combination with a conventional non-biologic disease-modifying antirheumatic drug (cDMARD) (e.g., methotrexate).

Skyrizi (risankizumab injection/ risankizumab for injection) is indicated for:

- the treatment of adults with moderately to severely active Crohn's disease who have had an inadequate response, intolerance, or demonstrated dependence to corticosteroids; or an inadequate response, intolerance, or loss of response to immunomodulators or biologic therapies.

1.1 Pediatrics (< 18 years of age)

Skyrizi is not indicated in the pediatric population.

Plaque Psoriasis and Psoriatic Arthritis

The efficacy and safety of Skyrizi have not been evaluated in patients with plaque psoriasis or psoriatic arthritis younger than 18 years of age.

Crohn's Disease

Of the 1574 subjects with Crohn's disease exposed to Skyrizi in clinical trials, 12 were 16 to 17 years of age. The efficacy and safety of Skyrizi have not been evaluated in pediatric patients with Crohn's disease younger than 16 years of age.

1.2 Geriatrics (≥ 65 years of age)

Limited data are available to Health Canada regarding this age group. Of the 2234 patients with plaque psoriasis exposed to Skyrizi in clinical trials, 243 (11%) were 65 years or older, including 24 (1%) who were 75 years or older. Of the 1574 subjects with Crohn's disease exposed to Skyrizi in clinical trials, 72 (5%) were 65 years or older, including 5 (0.3%) who were 75 years or older.

2 CONTRAINDICATIONS

- Skyrizi is contraindicated in patients who are hypersensitive to risankizumab or to any ingredient in the formulation or component of the container. For a complete listing, see [6.0 DOSAGE FORMS, STRENGTHS, COMPOSITION AND PACKAGING](#).

3 SERIOUS WARNINGS AND PRECAUTIONS BOX

Not applicable.

4 DOSAGE AND ADMINISTRATION

Skyrizi should be initiated and supervised by specialist physicians experienced in the diagnosis and treatment of plaque psoriasis, psoriatic arthritis, or Crohn's disease.

The AbbVie Care Patient Support Program has been established to facilitate patient access and administration of their treatment with Skyrizi. AbbVie Care Nurses are qualified health care professionals specially trained to provide injection support services including medication delivery, injection training and ongoing personalized care for patients treated with Skyrizi. AbbVie Care Support Program services are available across Canada. Information about the support services can be obtained by calling the AbbVie Care Support Program at 1-866-848-6472.

4.1 Dosing Considerations

- The intravenous infusion of Skyrizi should be administered only by a healthcare professional.
- Patients may self-inject Skyrizi subcutaneously if their physician determines that it is appropriate and with medical follow-up, as necessary, after proper training in subcutaneous injection technique. Patients should read the **Instructions for Use** before administration.
- If using Skyrizi 75 mg/ 0.83 mL (90 mg/mL) patients should be instructed to inject 2 pre-filled syringes for the full 150 mg dose. If using Skyrizi 150 mg/1 mL (150 mg/mL), patients should be instructed to inject 1 pre-filled syringe or pre-filled pen for the full 150 mg dose. Bioequivalence was demonstrated between a single risankizumab 150 mg/1 mL (150 mg/mL) injection and two risankizumab 75 mg/0.83 mL (90 mg/mL) injections in pre-filled syringe. Bioequivalence was also demonstrated between risankizumab 150 mg/1 mL (150 mg/mL) pre-filled syringe and pre-filled pen.
- If using Skyrizi 360 mg/2.4 mL (150 mg/mL) patients should be instructed to inject 1 pre-filled cartridge with on-body injector for the full 360 mg dose.
- Each pre-filled pen, pre-filled syringe, pre-filled cartridge with on-body injector, and vial is for single use only.
- Consider obtaining liver tests as per routine patient management prior to initiating treatment with Skyrizi in Crohn's disease patients.

4.2 Recommended Dose and Dosage Adjustment

Plaque Psoriasis

- The recommended dose of Skyrizi is 150 mg administered by subcutaneous injection at Week 0, Week 4, and every 12 weeks thereafter.

Psoriatic Arthritis

- The recommended dose of Skyrizi is 150 mg administered by subcutaneous injection at Week 0, Week 4, and every 12 weeks thereafter.

Crohn's Disease

- The recommended dose is 600 mg administered by intravenous infusion at Week 0, Week 4, and Week 8, followed by 360 mg administered by subcutaneous injection at Week 12, and every 8 weeks thereafter.

Pediatrics (< 18 years of age)

The efficacy and safety of Skyrizi have not been evaluated in patients with plaque psoriasis or psoriatic arthritis younger than 18 years of age.

Of the 1574 subjects with Crohn's disease exposed to Skyrizi, 12 subjects were 16 to 17 years of age.

Geriatrics (≥ 65 years of age)

Limited data are available to Health Canada regarding this age group. No dosage adjustment is required (see [1.2 Geriatrics \(≥ 65 years of age\)](#) and [10.3 Pharmacokinetics](#)).

Renal or Hepatic Impairment

No specific studies were conducted to assess the effect of hepatic or renal impairment on the pharmacokinetics of Skyrizi (see [10.3 Pharmacokinetics](#)).

4.3 Reconstitution

Instructions for dilution of the solution for intravenous infusion

1. Skyrizi should be prepared by a healthcare professional using aseptic technique prior to labeled expiry date.
2. Skyrizi medicinal product must be diluted before administration.
3. Skyrizi for intravenous administration must be diluted into an intravenous infusion bag or glass bottle containing 5% dextrose in water (D5W) (600 mg/10 mL in 100 mL, or 250 mL or 500 mL) to a final drug concentration of approximately 1.2 mg/mL to 6 mg/mL.
4. The solution in the vial and dilutions should not be shaken.
5. Once diluted, the solution can be stored (protected from direct and indirect light) at room temperature between 15 to 30°C (59 to 86°F) for administration within 8 hours (including the infusion period) or, refrigerated immediately for up to 20 hours between 2 and 8 °C (36 and 46 °F) for later administration. Once removed from refrigerated storage, the diluted solution should be administered within 8 hours (including the infusion period). Do not freeze.
6. Prior to the start of the intravenous infusion, the content of the infusion bag or glass bottle should be at room temperature.
7. Infuse the diluted solution over a period of at least one hour.
8. Skyrizi vial solution should not be administered concomitantly in the same intravenous line with other medicinal products.
9. Each vial is for single use only and any unused medicinal product or waste material should be disposed of in accordance with local requirements.

4.4 Administration

Plaque Psoriasis and Psoriatic Arthritis

Skyrizi is administered by subcutaneous injection. Patients should not inject into areas where the skin is tender, bruised, erythematous, indurated or affected by psoriasis. Skyrizi is intended for use under the guidance and supervision of a physician. Skyrizi may be administered by a healthcare professional or a patient or caregiver after proper training in subcutaneous injection technique.

For patients that require two injections for the full 150 mg dose, the injections should be administered at different anatomic locations (such as thighs or abdomen). Administration of Skyrizi in the upper, outer arm may only be performed by a healthcare professional or caregiver.

Preparation for Use

Before injecting the pre-filled pen, patients should remove the carton from the refrigerator and allow it to reach room temperature out of direct sunlight (30 to 90 minutes) without removing the pre-filled pen from the carton.

For a more comfortable injection, before injecting the pre-filled syringe, patients may remove the carton from the refrigerator and allow to reach room temperature out of direct sunlight (15 to 30 minutes) without removing the pre-filled syringe from the carton.

Visually inspect Skyrizi for particulate matter and discoloration prior to administration. The 150 mg/1 mL (150 mg/mL) solution is colourless to yellow and clear to slightly opalescent. The 75 mg/0.83 mL (90 mg/mL) solution is colourless to slightly yellow and clear to slightly opalescent. It may contain a few translucent to white product-related particles. Do not use if the solution is cloudy or discoloured, or contains large particles.

Crohn's Disease

The induction dose is administered by intravenous infusion after dilution (see [4.3 Reconstitution](#)). Intravenous Skyrizi infusion should be administered by a healthcare professional. It should be administered over at least one hour.

The maintenance dose is administered by subcutaneous injection. Patients should not inject into areas where the skin is tender, bruised, erythematous, indurated or affected by any lesions. Skyrizi may be administered subcutaneously by a healthcare professional or a patient or caregiver after proper training in subcutaneous injection technique.

Preparation for Use

Before using the on-body injector with a pre-filled cartridge, remove the carton from the refrigerator and allow to reach room temperature out of direct sunlight (45 to 90 minutes) without removing the on-body injector or pre-filled cartridge from the carton.

4.5 Missed Dose

If a dose is missed, administer the dose as soon as possible. Thereafter, resume dosing at the regular scheduled time.

5 OVERDOSAGE

In the event of overdose, it is recommended that the patient be monitored for any signs or symptoms of adverse reactions and appropriate symptomatic treatment be instituted immediately.

Single intravenous doses up to 1800 mg and multiple subcutaneous doses up to 360 mg of risankizumab have been administered in clinical trials without dose-limiting toxicity (see [4.2 Recommended Dose and Dosage Adjustment](#)).

For management of a suspected drug overdose, contact your regional poison control centre.

6 DOSAGE FORMS, STRENGTHS, COMPOSITION AND PACKAGING

Table 1 – Dosage Forms, Strengths, Composition and Packaging

Route of Administration	Dosage Form / Strength/Composition	Non-medicinal Ingredients
subcutaneous	Solution for injection/ 150 mg/mL 150 mg risankizumab in 1 mL solution	acetic acid, polysorbate 20, sodium acetate trihydrate, trehalose dihydrate, and water for injection
	Solution for injection/ 150 mg/mL 360 mg risankizumab in 2.4 mL solution	acetic acid, polysorbate 20, sodium acetate trihydrate, trehalose dihydrate, and water for injection
	Solution for injection / 90 mg/mL / 75 mg risankizumab in 0.83 mL solution	disodium succinate hexahydrate, polysorbate 20, sorbitol, succinic acid, and water for injection
intravenous infusion	Solution for intravenous infusion/ 60 mg/mL 600 mg risankizumab in 10 mL solution	acetic acid, polysorbate 20, sodium acetate trihydrate, trehalose dihydrate, and water for injection

Description

Skyrizi (risankizumab injection) 150 mg/1 mL (150 mg/mL)

Skyrizi is supplied as a solution for injection in a pre-filled pen or pre-filled syringe with needle guard containing 150 mg risankizumab in 1 mL sterile solution. Skyrizi does not contain preservatives; therefore, each pre-filled pen or pre-filled syringe is for single use only.

Skyrizi 150 mg/1 mL (150 mg/mL) is available in cartons containing 1 pre-filled pen or 1 pre-filled syringe.

Not made with natural rubber latex.

Skyrizi (risankizumab injection) 360 mg/2.4 mL (150 mg/mL)

Skyrizi is supplied as a solution for injection in a pre-filled cartridge containing 360 mg risankizumab in 2.4 mL sterile solution. Skyrizi does not contain preservatives; therefore, each pre-filled cartridge is for single use only.

Skyrizi 360 mg/2.4 mL (150 mg/mL) is available in cartons containing 1 pre-filled cartridge with 1 on-body injector.

Not made with natural rubber latex.

Skyrizi (risankizumab injection) 75 mg/0.83 mL (90 mg/mL)

Skyrizi is supplied as a solution for injection in a pre-filled syringe with needle guard. Each pre-filled syringe contains 75 mg risankizumab in 0.83 mL sterile solution. Skyrizi does not contain preservatives; therefore, each pre-filled syringe is for single use only.

Skyrizi 75 mg/0.83 mL (90 mg/mL) is available in cartons containing 2 pre-filled syringes.

Not made with natural rubber latex.

Intravenous Infusion

Skyrizi (risankizumab for injection) 600 mg/10 mL (60 mg/mL)

Skyrizi is supplied as a concentrate for solution for intravenous infusion in a vial containing 600 mg in 10 mL sterile solution. Skyrizi does not contain preservatives; therefore, each vial is for single use only.

Skyrizi 600 mg/10 mL (60 mg/mL) is available in cartons containing 1 vial.

7 WARNINGS AND PRECAUTIONS

General

Infections

Skyrizi (risankizumab injection) may increase the risk of infections (see [8.2 Clinical Trial Adverse Reactions](#)).

Skyrizi should not be given to patients with any clinically important active infection until the infection resolves or is adequately treated. In patients with a chronic infection or a history of recurrent infection, the risks and benefits should be considered prior to prescribing Skyrizi. Patients should be instructed to seek medical advice if signs or symptoms of a clinically important infection occur. If a patient develops such an infection or is not responding to standard therapy for the infection, the patient should be closely monitored and Skyrizi should not be administered until the infection resolves.

In clinical trials in plaque psoriasis, infections were reported in 22% of patients in the Skyrizi 150 mg group versus 15% of patients in the placebo group through 16 weeks of treatment. The most common type of infection reported in patients that received Skyrizi 150 mg were upper respiratory tract infections (see [8.2 Clinical Trial Adverse Reactions](#)).

Tuberculosis

Skyrizi must not be given to patients with active tuberculosis (TB). Evaluate patients for TB infection according to the Canadian Tuberculosis Standards prior to initiating treatment with Skyrizi. Initiate treatment of latent TB prior to initiating Skyrizi. Consider anti-TB therapy prior to initiating Skyrizi in patients with a past history of latent or active TB in whom an adequate course of treatment cannot be confirmed. Patients receiving Skyrizi should be monitored for signs and symptoms of active TB during and after the treatment.

Immune

Vaccinations

Prior to initiating therapy with Skyrizi, completion of all appropriate immunizations should be considered according to current immunization guidelines. Skyrizi should not be used with live vaccines. No data are available on the response to live or inactive vaccines.

If a patient has received live vaccination (viral or bacterial), it is recommended to wait at least four weeks prior to starting treatment with Skyrizi.

Reproductive Health: Female and Male Potential

- **Fertility**

The effect of Skyrizi on human fertility has not been studied. In addition, no dedicated fertility studies have been conducted in animals. In 26-week repeat-dose toxicity studies conducted in cynomolgus monkeys, no adverse effects on male or female reproductive organs or on male fertility-related parameters were observed (see [16 NON-CLINICAL TOXICOLOGY](#)).

Sensitivity/Resistance

As with all therapeutic proteins including Skyrizi, there is potential for anaphylaxis. If an anaphylactic or other serious allergic reaction occurs, immediately discontinue the administration of Skyrizi and initiate appropriate medical treatment.

Inform patients/caregivers of the signs and symptoms of anaphylaxis and hypersensitivity reactions, and instruct them to seek immediate medical care if signs and symptoms occur.

7.1 Special Populations

7.1.1 Pregnant Women

The use of Skyrizi in pregnant women has not been studied.

In an enhanced pre- and post-natal developmental study conducted in cynomolgus monkeys, fetal losses and neonatal deaths were observed following weekly subcutaneous injections of risankizumab at 5 or 50 mg/kg to pregnant monkeys from the beginning of organogenesis until parturition at exposure values that were 13- to 99-fold greater than the human exposure levels in patients with plaque psoriasis. For Crohn's disease, these doses in cynomolgus monkeys produced exposures that were 1.24- to 10-fold greater than human exposure levels during induction at a dose of 600 mg IV every 4 weeks and 5- to 39-fold greater than human exposure levels during maintenance when given 360 mg SC every 8 weeks. No adverse developmental effects were observed in surviving monkey infants. In addition, risankizumab was detected in monkey infant serum (see [16 NON-CLINICAL TOXICOLOGY](#)).

Animal studies are not always predictive of human response; therefore, it is unknown whether Skyrizi can cause fetal harm when administered to a pregnant woman.

Women of childbearing potential should use adequate contraception while using Skyrizi and for at least 20 weeks after the last Skyrizi dose.

7.1.2 Breast-feeding

There are no data on the presence of risankizumab in human milk, the effects on the breastfed infant, or the effects on milk production. Because human immunoglobulin G (IgG) is secreted into human milk, precaution should be exercised. The developmental and health benefits of breast-feeding should be considered, as well as any potential adverse effects on the breastfed infant.

7.1.3 Pediatrics (< 18 years of age)

Skyrizi is not indicated in the pediatric population with plaque psoriasis or psoriatic arthritis, as the efficacy and safety of Skyrizi have not been evaluated in patients younger than 18 years of age.

Of the 1574 subjects with Crohn's disease exposed to Skyrizi, 12 subjects were 16 to 17 years of age. The safety and efficacy of Skyrizi in pediatric patients with Crohn's disease younger than 16 years of age have not yet been evaluated.

7.1.4 Geriatrics (≥ 65 years of age)

Limited data are available regarding this age group (see [1.2 Geriatrics \(≥ 65 years of age\)](#) and [4.2 Recommended Dose and Dosage Adjustment](#)).

8 ADVERSE REACTIONS

8.1 Adverse Reaction Overview

The most frequently reported (≥10%) adverse drug reactions were upper respiratory tract infections. Most of the reactions were mild or moderate in severity.

In the placebo-controlled period of the phase 3 studies, the proportion of patients who discontinued treatment due to adverse events was 0.5% in Skyrizi 150 mg-treated patients and 3.0% in placebo-treated patients in plaque psoriasis studies, and 0.7% in Skyrizi 150 mg-treated patients and 1.4% in placebo-treated patients in psoriatic arthritis studies. Serious adverse events were reported in 2.4% of Skyrizi 150 mg-treated patients and 4.0% of placebo-treated patients in plaque psoriasis studies, and 3.0% of Skyrizi 150 mg-treated patients and 4.4% of placebo-treated patients in psoriatic arthritis studies.

8.2 Clinical Trial Adverse Reactions

Clinical trials are conducted under very specific conditions. The adverse reaction rates observed in the clinical trials; therefore, may not reflect the rates observed in practice and should not be compared with the rates in the clinical trials of another drug. Adverse reaction information from clinical trials may be useful in identifying and approximating rates of adverse drug reactions in real-world use.

Adverse Reactions in Plaque Psoriasis Trials

A total of 2234 patients were treated with Skyrizi in clinical development studies in plaque psoriasis, representing 2167 patient years of exposure. Of these, 1208 (54%) patients with psoriasis were exposed to Skyrizi for at least one year. Safety results from 111 patients exposed to Skyrizi for 104 weeks in the IMMSTANCE study are consistent with the safety profile of Skyrizi in other psoriasis studies.

Data from placebo- and active-controlled studies were pooled to evaluate the safety of Skyrizi for up to 16 weeks. In total, 1306 patients were evaluated in the Skyrizi 150 mg group.

Table 2 summarizes the adverse reactions that occurred at a rate of at least 1% and at a higher rate in the Skyrizi group than the placebo group during the 16-week controlled period of pooled clinical studies.

Table 2 – Adverse Reactions Occurring in ≥ 1% of Patients with Plaque Psoriasis through Week 16

	Skyrizi ¹ N = 1306 n (%)	Placebo ² N = 300 n (%)	Ustekinumab ³ N = 199 n (%)	Adalimumab ⁴ N = 304 n (%)
General Disorders and Administration Site Conditions				
Fatigue ⁵	33 (2.5)	3 (1.0)	5 (2.5)	8 (2.6)
Injection site reactions ⁶	19 (1.5)	3 (1.0)	5 (2.5)	17 (5.6)
Infections and Infestations				
Upper respiratory tract infections ⁷	170 (13.0)	29 (9.7)	25 (12.6)	42 (13.8)
Urinary tract infection	14 (1.1)	2 (0.7)	5 (2.5)	3 (1.0)
Tinea infections ⁸	15 (1.1)	1 (0.3)	0 (0)	2 (0.7)
Nervous System Disorders				
Headache ⁹	46 (3.5)	6 (2.0)	7 (3.5)	20 (6.6)
Skin and Subcutaneous Tissue Disorders				
Pruritus	19 (1.5)	4 (1.3)	3 (1.5)	10 (3.3)

1 Includes data from ULTIMMA-1, ULTIMMA-2, IMMSTANCE and IMMVENT studies. Patients received Skyrizi 150 mg at Week 0 and Week 4.

2 Includes data from ULTIMMA-1, ULTIMMA-2 and IMMSTANCE studies. Patients received placebo at Week 0 and Week 4.

3 Includes data from ULTIMMA-1 and ULTIMMA-2 studies. Patients received a weight-based dose of ustekinumab: 45 mg (weight ≤ 100 kg) or 90 mg (weight > 100 kg) at Week 0 and Week 4.

4 Includes data from IMMVENT study. Patients received adalimumab 80 mg at Week 0, 40 mg at Week 1, then every other week (q2wk) thereafter.

5 Includes: fatigue, asthenia

6 Includes: injection site bruising, erythema, extravasation, hematoma, hemorrhage, infection, inflammation, irritation, pain, pruritus, reaction, swelling, warmth

7 Includes: respiratory tract infection (viral, bacterial, or unspecified), sinusitis (including acute), rhinitis, nasopharyngitis, pharyngitis (including viral), tonsillitis

8 Includes: tinea pedis, tinea cruris, body tinea, tinea versicolor, tinea manuum, tinea infection, onychomycosis

9 Includes: headache, tension headache, sinus headache, cervicogenic headache

Adverse Reactions in Psoriatic Arthritis Trials

Overall, the safety profile observed in patients with psoriatic arthritis treated with Skyrizi was consistent with the safety profile observed in patients with plaque psoriasis.

A total of 1,407 patients were treated with Skyrizi in Phase 3 clinical development studies in psoriatic arthritis. Data from two placebo- controlled studies, KEEPSAKE1 and KEEPSAKE2, were pooled to evaluate the safety of Skyrizi for up to 24 weeks.

Table 3 summarizes the adverse reactions that occurred at a rate of at least 1% and at a higher rate in the Skyrizi group than the placebo group during the 24-week controlled period of pooled studies KEEPSAKE1 and KEEPSAKE2.

Table 3 – Adverse Reactions Occurring in ≥ 1% of Patients with Psoriatic Arthritis through Week 24

	KEEPSAKE1 and KEEPSAKE2	
	Skyrizi N =707 n (%)	Placebo N =700 n (%)
Infections and Infestations¹		
Upper respiratory tract infection	71 (10.0)	67 (9.6)

1 includes: acute sinusitis, nasopharyngitis, pharyngitis, respiratory tract infection, respiratory tract infection viral, rhinitis, sinusitis, tonsillitis, upper respiratory tract infection, upper respiratory tract infection bacterial, viral pharyngitis, viral upper respiratory tract infection

Adverse Reactions in Crohn’s Disease Trials

The adverse drug reaction profile observed in patients with Crohn’s disease treated with Skyrizi was generally consistent with the adverse drug reaction profile observed in patients with plaque psoriasis. Elevated liver enzymes have been reported in patients with Crohn’s disease during induction. Consider monitoring liver enzymes as clinically indicated.

Infections

Plaque Psoriasis

In the first 16 weeks, infections occurred in 22.1% (288/1306) of the Skyrizi 150 mg group (90.8 events per 100 patient-years) compared with 14.7% (44/300) of the placebo group (56.5 events per 100 patient-years). The majority of cases were non-serious and mild to moderate in severity and did not lead to discontinuation of Skyrizi. Serious infections were reported in 5 (0.4%) Skyrizi 150 mg-treated patients and in 1 (0.3%) placebo-treated patient (see [7 WARNINGS AND PRECAUTIONS](#)).

Over the entire psoriasis program including long-term exposure to Skyrizi 150 mg, the rate of infections was 48% (759/1590, 79 events per 100 patient-years); the rate of serious infections was 1.4% (22/1590, 1.6 events per 100 patient-years).

Psoriatic Arthritis

In the first 24 weeks, infections occurred in 19.0% of the Skyrizi 150 mg group compared with 19.3% of the placebo group. The most common infection adverse events in the Skyrizi group ($\geq 1\%$ of subjects) were upper respiratory tract infection (4.1%), nasopharyngitis (3.5%), and gastroenteritis (1.0%). The majority of infections were non-serious and mild to moderate in severity and did not lead to discontinuation of Skyrizi. Serious infections were reported in 1.0% of Skyrizi 150 mg-treated patients and in 1.6% of placebo-treated patients.

Crohn's Disease

The rate of infections in the pooled data from the 12-week induction studies was 19.2% (83.3 events per 100 subject-years) in subjects treated with Skyrizi 600 mg IV compared to 24.4% (117.7 events per 100 subject-years in placebo). The rate of serious infections was 0.9% (3.4 events per 100 subject-years) in subjects treated with Skyrizi 600 mg IV compared to 3.6% (16.7 events per 100 subject-years in placebo).

The rate of infections in the 52-week maintenance study was 34.1% (57.7 events per 100 subject-years) in subjects treated with Skyrizi 360 mg SC after Skyrizi induction compared to 40.2% (76.0 events per 100 subject-years) in subjects who received placebo after Skyrizi induction. The rate of serious infections was 4.5% (6.0 events per 100 subject-years) in subjects treated with Skyrizi 360 mg SC after Skyrizi induction compared to 3.8% (5.0 events per 100 subject-years) in subjects who received placebo after Skyrizi induction.

The majority of infections were non-serious and mild to moderate in severity and did not lead to discontinuation of Skyrizi.

Immunogenicity

As with all therapeutic proteins, there is the potential for immunogenicity with Skyrizi. Immunogenicity tests are generally product-specific and are highly dependent on the sensitivity and specificity of the assay. Comparison of incidence of antibodies between products by different tests may be misleading.

Plaque Psoriasis

For patients treated with Skyrizi at the recommended clinical dose for up to 52 weeks in psoriasis clinical trials, treatment-emergent anti-drug antibodies were detected in 24% (263/1079) of evaluated patients. Of the patients who developed antidrug antibodies, approximately 57% had antibodies that were classified as neutralizing which equates to 14% (150/1079) of all patients treated with Skyrizi.

Antibodies to risankizumab including neutralizing antibodies were not generally associated with changes in clinical response or safety. Among the few patients (approximately 1%; 7/1000 at Week 16 and 6/598 at Week 52) with high antibody titers (> 128), clinical response appeared to be reduced.

Psoriatic Arthritis

For patients treated with Skyrizi at the recommended clinical dose for up to 28 weeks in psoriatic arthritis clinical trials, treatment-emergent anti-drug antibodies and neutralizing antibodies were detected in 12.1% (79/652) and 0% (0/652) of evaluated patients, respectively. There was no evidence of impact of anti-drug antibody development on efficacy in the clinical studies. A higher proportion of subjects with anti-drug antibodies experienced hypersensitivity reactions (6.3% [5/79]) and injection site reactions (2.5% [2/79]) compared to subjects without anti-drug antibodies (3.8% [22/574] with hypersensitivity reactions and 0.7% [4/574] with injection site reactions). None of these hypersensitivity and injection site reactions led to discontinuation of risankizumab.

Crohn's Disease

A total of 13/607 (2.1%) of Crohn's disease patients dosed at 600 mg IV every four weeks (Q4W), and 1/107 (0.9%) patients dosed at 360 mg SC (regardless of induction treatment) were positive for treatment-emergent anti-drug antibodies during the first 12 weeks of induction period and during the 52 weeks of maintenance period, respectively. Of these, neutralizing antibodies were detected in 2/607 (0.3%) patients dosed at 600 mg IV Q4W, and no patients dosed at 360 mg SC were positive for neutralizing antibodies.

Antibodies to risankizumab were not associated with changes in clinical response or safety for Crohn's disease based on these limited data.

8.3 Less Common Clinical Trial Adverse Reactions

Plaque Psoriasis

Adverse reactions that occurred at rates less than 1% in the placebo-controlled period of the plaque psoriasis studies ULTIMMA-1, ULTIMMA-2, IMMSTANCE and IMMVENT through Week 16 included:

Infections and Infestations: Folliculitis

Psoriatic Arthritis

Adverse reactions that occurred at rates less than 1% in the placebo-controlled period of the psoriatic arthritis studies KEEPSAKE1 and KEEPSAKE2 through Week 24 included:

Infections and Infestations: Folliculitis, tinea infections (which includes onychomycosis, tinea cruris)

Skin and Subcutaneous Tissue Disorders: Injection site reactions (which includes Injection site erythema, Injection site pruritus, Injection site swelling)

8.4 Post-Market Adverse Reactions

The following adverse reactions have been identified during post-approval use of Skyrizi. Because these reactions are reported voluntarily from a population of uncertain size, it is not always possible to reliably estimate their frequency or establish a causal relationship to drug exposure.

Skin and Subcutaneous Tissue Disorders: Eczema, rash, and urticaria.

9 DRUG INTERACTIONS

9.2 Drug Interactions Overview

Skyrizi is not expected to undergo metabolism by hepatic enzymes or renal elimination. Drug interactions between Skyrizi and substrates/inhibitors/inducers of drug metabolizing enzymes are not expected.

9.3 Drug-Behavioural Interactions

Interactions with behaviour have not been studied.

9.4 Drug-Drug Interactions

Live Vaccines

Live vaccines should not be given while a patient is undergoing therapy with Skyrizi (see [7 WARNINGS AND PRECAUTIONS](#)).

Immunosuppression Therapy

The safety and efficacy of Skyrizi in combination with immunosuppressant drugs, including biologics, or with phototherapy, have not been evaluated.

Interactions with CYP450 Substrates

The formation of cytochrome P450 (CYP) enzymes can be altered by increased levels of certain cytokines (e.g., interleukin [IL]- β , IL-6, tumor necrosis factor, and interferon) during chronic inflammation. A drug interaction study was conducted in patients with plaque psoriasis to assess the effect of repeated administration of risankizumab injection on the pharmacokinetics of cytochrome P450 (CYP) sensitive probe substrates. The exposure of caffeine (CYP1A2 substrate), warfarin (CYP2C9 substrate), omeprazole (CYP2C19 substrate), metoprolol (CYP2D6 substrate) and midazolam (CYP3A substrate) following administration of risankizumab injection were comparable to their exposures prior to risankizumab injection, indicating no interactions through these enzymes.

Population pharmacokinetic analyses indicated that risankizumab exposure was not clinically meaningfully impacted by concomitant medications (metformin, atorvastatin, lisinopril, amlodipine, ibuprofen, acetylsalicylate, levothyroxine and vitamin B complex) used by some patients with plaque psoriasis during the clinical studies. Similarly, no clinically meaningful impact on risankizumab exposure was observed with concomitant use of methotrexate in patients with psoriatic arthritis or with concomitant use of corticosteroids in patients with Crohn's disease, based on population pharmacokinetic analyses.

9.5 Drug-Food Interactions

Interactions with food have not been studied.

9.6 Drug-Herb Interactions

Interactions with herbal products have not been studied.

9.7 Drug-Laboratory Test Interactions

Interactions with laboratory tests have not been studied.

10 CLINICAL PHARMACOLOGY

10.1 Mechanism of Action

Risankizumab is a humanized immunoglobulin G1 (IgG1) monoclonal antibody that selectively binds with high affinity to the p19 subunit of human interleukin 23 (IL-23) cytokine and inhibits IL-23 signalling in cell-based assays, including the release of the pro-inflammatory cytokine, IL-17. IL-23 is a naturally occurring cytokine that is involved in inflammatory and immune responses. Risankizumab was shown to not bind to human IL-12 in vitro.

10.2 Pharmacodynamics

No formal pharmacodynamic studies have been conducted with risankizumab.

10.3 Pharmacokinetics

The pharmacokinetics of risankizumab was similar between patients with plaque psoriasis and psoriatic arthritis.

Risankizumab exhibited linear pharmacokinetics with dose-proportional increase in exposure across dose ranges of 18 to 360 mg and 0.25 to 1 mg/kg administered subcutaneously, and 200 to 1800 mg and 0.01 to 5 mg/kg administered intravenously.

Table 4 - Non-compartmental pharmacokinetic parameters following single dose administration of risankizumab in healthy subjects

	C_{max} (mcg/mL)	T_{max} (days)	t_½ (days)	AUC_{0-∞} (mcg.day/mL)	CL/F (for SC) or CL (for IV) (L/day)	V_d/F (for SC) or V_d (for IV) (L)
150 mg SC	14.2	5.0	27.4	613	0.268	10.6
360 mg SC	36.1	7.0	27.0	1650	0.241	9.4
600 mg IV	225	0.1	30.7	3620	0.167	7.4

Values are arithmetic means except for T_{max} (median) and t_{1/2} (harmonic mean)

SC = subcutaneous; IV = intravenous; C_{max} = maximum observed systemic concentration; T_{max} = time to maximum observed systemic concentration; t_½ = terminal phase elimination half-life; AUC_{0-∞} = area under the concentration-time curve from time zero to infinite time; CL/F = apparent systemic clearance following extravascular administration; CL = systemic clearance following intravenous administration; V_d/F = apparent volume of distribution determined by terminal phase rate constant following extravascular administration; V_d = apparent volume of distribution determined by terminal phase rate constant following intravenous administration

Absorption

Following subcutaneous dosing of risankizumab, peak plasma concentrations were achieved between 3 to 14 days after dosing with an estimated absolute bioavailability of 74 to 89% based on population pharmacokinetic analyses.

Following a single 300 mg subcutaneous injection in healthy Caucasian subjects, risankizumab reached a mean (± SD) maximum plasma concentration (C_{max}) of 20.4 ± 8.02 mcg/mL by approximately 7 days post dose.

With the dosing regimen in patients with plaque psoriasis (150 mg at Week 0, Week 4, and every 12 weeks thereafter), population pharmacokinetic estimated mean (\pm SD) steady-state peak and trough plasma concentrations are 11.9 ± 3.06 and 1.91 ± 1.17 mcg/mL, respectively. The pharmacokinetics of risankizumab were similar between patients with plaque psoriasis and psoriatic arthritis.

In subjects with Crohn's disease treated with 600 mg IV induction dose at Weeks 0, 4, and 8 followed by 360 mg SC maintenance dose at Week 12 and every 8 weeks thereafter, maximum median peak and trough concentrations are estimated to be 156 and 38.8 mcg/mL respectively during the induction period (Weeks 8-12) and steady state median peak and trough concentrations are estimated to be 28.0 and 8.13 mcg/mL respectively during the maintenance period (Weeks 40 to 48) based on population pharmacokinetic modeling.

Distribution:

Based on population pharmacokinetic analyses, in a typical 90 kg patient with psoriasis, the steady-state volume of distribution (V_{ss}) was 11.2 L. In a typical 70 kg subject with Crohn's disease, V_{ss} was 7.68 L.

Metabolism:

The exact pathway through which risankizumab is metabolized has not been characterized. Therapeutic IgG monoclonal antibodies are typically degraded into small peptides and amino acids via catabolic pathways in the same manner as endogenous IgGs.

Elimination

Following a single 300 mg subcutaneous injection in healthy Caucasian subjects, risankizumab mean terminal elimination half-life ($T_{1/2}$) was approximately 29 days. Based on population pharmacokinetic analyses, the systemic clearance (CL) of risankizumab was 0.31 L/day and $T_{1/2}$ was 28 days for a typical 90 kg patient with psoriasis. For a typical 70 kg subject with Crohn's disease, CL was 0.30 L/day and terminal elimination half-life was 21 days.

Special Populations and Conditions

- **Pediatrics**

The pharmacokinetics of risankizumab in pediatric patients under 16 years of age has not been evaluated. Age was not found to have any significant impact on risankizumab exposure in subjects aged 16 years and older based on the population pharmacokinetic analyses.

- **Geriatrics**

Of the 2234 patients with plaque psoriasis exposed to Skyrizi, a total of 243 were 65 years or older, and 24 patients were 75 years or older. Of the 1574 subjects with Crohn's disease exposed to Skyrizi, 72 were 65 years or older. Based on population pharmacokinetic analyses in this limited patient population, there was no clinically meaningful difference in risankizumab exposure between patients 65 years of age or older and adult patients.

- **Sex**

Based on the population pharmacokinetic analyses, the clearance of risankizumab was not significantly influenced by gender in adult patients with plaque psoriasis, psoriatic arthritis or Crohn's disease.

- **Ethnic Origin**

No clinically meaningful differences in risankizumab exposure were found in 19 Chinese or 36 Japanese subjects compared with 12 Caucasian subjects in a clinical pharmacokinetic study in healthy subjects. Based on population pharmacokinetic analyses, race or ethnicity did not impact risankizumab clearance in patients with plaque psoriasis, psoriatic arthritis, or Crohn's disease.

- **Hepatic Insufficiency**

No specific studies have been conducted to determine the effect of hepatic impairment on the pharmacokinetics of risankizumab. As an IgG1 monoclonal antibody, risankizumab is not expected to be metabolized by hepatic cytochrome P450 enzymes.

- **Renal Insufficiency**

No specific studies have been conducted to determine the effect of renal impairment on the pharmacokinetics of risankizumab. As an IgG1 monoclonal antibody, risankizumab is not expected to be cleared via renal elimination.

- **Obesity**

Risankizumab clearance and volume of distribution increase as body weight increases. Data from a limited number of patients with plaque psoriasis (N = 38) indicate that high body weight (>130 kg) may result in reduced efficacy.

11 STORAGE, STABILITY AND DISPOSAL

Temperature:

Store in a refrigerator between 2 and 8 °C (36 and 46 °F). Do not freeze.

Skyrizi 150 mg/mL pre-filled pen or pre-filled syringe may be stored out of the refrigerator (up to a maximum of 25°C [77°F]) for up to 24 hours in the original carton to protect from light.

Skyrizi 60 mg/mL vial for intravenous infusion, once reconstituted, can be stored at room temperature between 15 to 30°C (59 to 86°F) for administration within 8 hours (including the infusion period) or, refrigerated immediately for up to 20 hours between 2 and 8 °C (36 and 46 °F) for later administration. Once removed from refrigerated storage, the diluted solution should be administered within 8 hours (including the infusion period). Do not freeze.

Light:

Keep in the outer carton in order to protect from light.

The diluted solution for intravenous infusion should be protected from direct and indirect light and sunlight.

Others:

Keep out of reach and sight of children.

12 SPECIAL HANDLING INSTRUCTIONS

Any unused medicinal product or waste material should be disposed of in accordance with local requirements.

PART II: SCIENTIFIC INFORMATION

13 PHARMACEUTICAL INFORMATION

Drug Substance

Proper name:	Risankizumab
Chemical name:	Not applicable. Risankizumab is an immunoglobulin.
Molecular formula and molecular mass:	Based on the amino acid sequence, the molecular formula of the disulfide bonded risankizumab molecule without post-translational modifications is $C_{6476}H_{9992}N_{1720}O_{2016}S_{44}$. The predicted molecular weight of aglycosylated risankizumab is approximately 146 kDa.
Structural formula:	Risankizumab is a recombinant humanized IgG1 kappa immunoglobulin comprising two heavy chains, and two light chains. The heavy and light chains are covalently linked by a single disulfide bond and the heavy chains are linked to each other by two disulfide bonds. Each heavy chain contains a single N-linked glycosylation site.
Physicochemical properties:	<p>Risankizumab is supplied as a sterile, preservative-free solution for subcutaneous administration.</p> <p>The 150 mg/1 mL and 360 mg/2.4 mL (150 mg/mL) solution is colourless to yellow and clear to slightly opalescent, with a pH of 5.7. The 75 mg/0.83 mL (90 mg/mL) solution is colourless to slightly yellow and clear to slightly opalescent, with a pH of 6.2.</p> <p>Risankizumab is supplied as a concentrate for solution for intravenous infusion. The 600 mg/10 mL (60 mg/mL) a colourless to slightly yellow, and clear to slightly opalescent solution, with a pH of 5.7.</p> <p>The solution may contain a few translucent to white product-related particles.</p>

14 CLINICAL TRIALS

14.1 Clinical Trials by Indication

Plaque Psoriasis

The efficacy and safety of Skyrizi (risankizumab injection) was assessed in 2109 adult patients with moderate to severe plaque psoriasis in four multicenter, randomized, double-blind studies (ULTIMMA-1, ULTIMMA-2, IMMSTANCE, and IMMVENT). Enrolled patients were 18 years of age and older with plaque psoriasis who had a body surface area (BSA) involvement of $\geq 10\%$, a static Physician Global Assessment (sPGA) score of ≥ 3 (moderate psoriasis) on a 5-point severity scale, a Psoriasis Area and Severity Index (PASI) score ≥ 12 , and who were candidates for systemic therapy or phototherapy. Patients with guttate, erythrodermic, or pustular psoriasis were excluded from the studies.

ULTIMMA-1 and ULTIMMA-2 enrolled 997 patients (598 randomized to Skyrizi 150 mg, 199 to ustekinumab 45 mg [≤ 100 kg body weight] or 90 mg [> 100 kg body weight]) and 200 to placebo). Patients received treatment at Week 0, Week 4, and every 12 weeks thereafter.

IMMSTANCE enrolled 507 patients (407 randomized to Skyrizi 150 mg and 100 to placebo). Patients received treatment at Week 0, Week 4 and every 12 weeks thereafter. Patients who were originally on Skyrizi and had a sPGA response of clear or almost clear (0/1) at Week 28 were re-randomized to continue Skyrizi every 12 weeks or have treatment withdrawn.

IMMVENT enrolled 605 patients (301 randomized to Skyrizi and 304 to adalimumab). Patients randomized to Skyrizi received 150 mg of treatment at Week 0, Week 4 and every 12 weeks thereafter. Patients randomized to adalimumab received 80 mg at Week 0, 40 mg at Week 1 and 40 mg every other week through Week 15. Starting at Week 16, patients who were receiving adalimumab continued or switched treatment based on response:

- $< \text{PASI } 50$ were switched to Skyrizi
- $\text{PASI } 50$ to $< \text{PASI } 90$ were re-randomized to either continue adalimumab or switch to Skyrizi
- $\text{PASI } 90$ continued to receive adalimumab

In all four Phase 3 studies, randomization was stratified by weight (≤ 100 kg versus > 100 kg) and by prior exposure to tumor necrosis factor (TNF) antagonists (0 versus ≥ 1).

In ULTIMMA-1 and ULTIMMA-2, the co-primary endpoints were the proportions of patients who achieved PASI 90 and sPGA of 0/1 at Week 16, comparing Skyrizi to placebo. In IMMSTANCE, the co-primary endpoints at Week 16 were the proportions of patients who achieved PASI 90 and sPGA of 0/1, comparing Skyrizi to placebo. In IMMVENT, the co-primary endpoints at Week 16 were the proportions of patients who achieved PASI 90 and sPGA of 0/1, comparing Skyrizi to adalimumab.

Other endpoints included the proportion of patients who achieved PASI 75, PASI 100, and sPGA of clear (0). Patient-reported outcomes were assessed based on the Dermatology Life Quality Index (DLQI) and Psoriasis Symptom Scale (PSS).

Patient demographics (**Table 5**) and baseline disease characteristics were generally balanced across treatment groups and studies. The majority of patients who were randomized to Skyrizi were male (69.5%) and white (78.1%). Overall, patients had a median baseline PASI score of 17.8 and a median BSA of 20.0%. Baseline sPGA score was severe in 19.3% of patients. A total of 9.8% of study patients had a history of diagnosed psoriatic arthritis.

Across all studies, 38.1% of patients had received prior phototherapy, 48.3% had received prior non-biologic systemic therapy, and 42.1% had received prior biologic therapy for the treatment of psoriasis. Of the patients who had received prior biologic therapy, 23.7% had received at least one anti-tumor necrosis factor (TNF) alpha agent.

Table 5 – Summary of Patient Demographics for Clinical Trials in Plaque Psoriasis

Study #	Trial Design	Dosage, Route of Administration, and Schedule ^a	Number of Study Patients	Mean Age (Range) Years	Sex n (%)
ULTIMMA-1	Phase 3, randomized, PBO and active-controlled, DB, double dummy, parallel study	RZB 150 mg SC Wks 0, 4, then q12w starting at Wk 16; UST 45 mg SC (\leq 100 kg) or 90 mg SC ($>$ 100 kg) Wks 0, 4, then q12w starting at Wk 16; PBO SC Wks 0, 4, then RZB 150 mg q12w starting at Wk 16	RZB: 304 UST: 100 PBO: 102	48.1 (19 – 85)	Female 145 (28.7) Male 361 (71.3)
ULTIMMA-2	Phase 3, randomized, PBO and active-controlled, DB, double dummy, parallel study	RZB 150 mg SC Wks 0, 4, then q12w starting at Wk 16; UST 45 mg SC (\leq 100 kg) or 90 mg SC ($>$ 100 kg) Wks 0, 4, then q12w starting at Wk 16; PBO SC Wks 0, 4, then RZB 150 mg q12w starting at Wk 16	RZB: 294 UST: 99 PBO: 98	46.7 (19 – 76)	Female 155 (31.6) Male 336 (68.4)
IMMHANCE	Phase 3, randomized, DB, PBO-controlled study with re-randomization at Wk 28 to RZB or PBO based on response	RZB 150 mg SC Wks 0, 4, then q12w starting at Wk 16; PBO SC Wks 0, 4, then RZB q12w starting at Wk 16	RZB: 407 PBO: 100	49.2 (19 – 80)	Female 151 (29.8) Male 356 (70.2)
IMMVENT	Phase 3, randomized, active-controlled, DB, double dummy, parallel study with re-randomization at Wk 16 to RZB or ADA based on response to ADA	RZB 150 mg SC Wks 0, 4, then q12w starting at Wk 16; ADA 80 mg SC Wk 0, 40 mg SC Wk 1, then 40 mg SC q2w	RZB: 301 ADA: 304	46.2 (18 – 81)	Female 183 (30.2) Male 422 (69.8)

DB = double blind; SC = subcutaneous; PBO = placebo; RZB = risankizumab; UST = ustekinumab; ADA = adalimumab; q12w = every 12 weeks; q2w = every 2 weeks; wk = week

^a Detailed information about dosage, route of administration and duration of these clinical trials are included above in this section.

The results of the ULTIMMA-1 and ULTIMMA-2 studies are presented in **Table 6** and **Table 7**.

In ULTIMMA-1 and ULTIMMA-2, Skyrizi demonstrated superiority to placebo for the co-primary endpoints of PASI 90 and sPGA of 0/1 (clear or almost clear) at Week 16 (**Table 6**).

Table 6 – Co-Primary Endpoint Results at Week 16 (NRI^a) in Adults with Plaque Psoriasis in ULTIMMA-1 and ULTIMMA-2

	ULTIMMA-1 ^b			ULTIMMA-2 ^b		
	Skyrizi N = 304 n (%)	Placebo N = 102 n (%)	Treatment Difference % (95% CI)	Skyrizi N = 294 n (%)	Placebo N = 98 n (%)	Treatment Difference % (95% CI)
sPGA of 0/1	267 (87.8)	8 (7.8)	79.9 (73.5, 86.3) ^c	246 (83.7)	5 (5.1)	78.5 (72.4, 84.5) ^c
PASI 90	229 (75.3)	5 (4.9)	70.3 (64.0, 76.7) ^c	220 (74.8)	2 (2.0)	72.5 (66.8, 78.2) ^c

^a Non-responder imputation (NRI) was used to impute missing data

^b Treatment differences, 95% CIs and p-values were based on the Cochran-Mantel-Haenszel test stratified by weight (≤ 100 kg versus > 100 kg) and prior TNF exposure (0 versus ≥ 1)

^c $p < 0.001$

Table 7 – Secondary Endpoint Results (NRI^a) in Adults with Plaque Psoriasis in ULTIMMA-1 and ULTIMMA-2

	ULTIMMA-1 ^b			ULTIMMA-2 ^b		
	Skyrizi N = 304 n (%)	Ustekinumab N = 100 n (%)	Placebo N = 102 n (%)	Skyrizi N = 294 n (%)	Ustekinumab N = 99 n (%)	Placebo N = 98 n (%)
sPGA of 0/1						
Week 16	267 (87.8)	63 (63.0)	*	246 (83.7)	61 (61.6)	*
Difference vs Ustekinumab % (95% CI)	25.1 (15.2, 35.0)			22.3 (12.0, 32.5)		
sPGA of 0						
Week 16	112 (36.8)	14 (14.0)	2 (2.0)	150 (51.0)	25 (25.3)	3 (3.1)
Difference vs Ustekinumab % (95% CI)	22.9 (14.3, 31.6)			26.3 (16.1, 36.4)		
Difference vs Placebo % (95% CI)	34.7 (28.6, 40.8)			47.5 (40.9, 54.2)		

	ULTIMMA-1 ^b			ULTIMMA-2 ^b		
	Skyrizi N = 304 n (%)	Ustekinumab N = 100 n (%)	Placebo N = 102 n (%)	Skyrizi N = 294 n (%)	Ustekinumab N = 99 n (%)	Placebo N = 98 n (%)
Week 52	175 (57.6)	21 (21.0)	NA ^c	175 (59.5)	30 (30.3)	NA ^c
Difference vs Ustekinumab % (95% CI)	36.5 (27.0, 45.9)			29.5 (18.9, 40.1)		
PASI 90						
Week 16	229 (75.3)	42 (42.0)	*	220 (74.8)	47 (47.5)	*
Difference vs Ustekinumab % (95% CI)	33.5 (22.7, 44.3)			27.6 (16.7, 38.5)		
Week 52	249 (81.9)	44 (44.0)	NA ^c	237 (80.6)	50 (50.5)	NA ^c
Difference vs Ustekinumab % (95% CI)	38.3 (27.9, 48.6)			30.2 (19.6, 40.9)		
PASI 100						
Week 16	109 (35.9)	12 (12.0)	0 (0.0)	149 (50.7)	24 (24.2)	2 (2.0)
Difference vs Ustekinumab % (95% CI)	23.8 (15.5, 32.1)			27.0 (17.0, 37.0)		
Difference vs Placebo % (95% CI)	35.5 (30.0, 41.0)			48.2 (41.9, 54.6)		
Week 52	171 (56.3)	21 (21.0)	NA ^c	175 (59.5)	30 (30.3)	NA ^c
Difference vs Ustekinumab % (95% CI)	35.1 (25.7, 44.6)			29.5 (18.9, 40.1)		

* sPGA of 0/1 and PASI 90 versus placebo at Week 16 were co-primary endpoints in **Table 6**.

^a Non-responder imputation (NRI) was used to impute missing data

^b Treatment differences and 95% CIs (for Skyrizi vs Ustekinumab and for Skyrizi vs Placebo) were based on the Cochran-Mantel-Haenszel test stratified by weight (≤ 100 kg versus > 100 kg) and prior TNF exposure (0 versus ≥ 1). Type I error rate for the multiple endpoints was controlled using a pre-defined hierarchical testing procedure.

^c NA = Not Applicable as comparisons to placebo were not possible at Week 52.

The results of the IMMSTANCE study are presented in **Table 8** and **Table 9**.

Table 8 – Efficacy Results at Week 16 (NRIa) in Adults with Plaque Psoriasis in IMMSTANCE

	Skyrizi (N = 407) n (%)	Placebo (N = 100) n (%)	Treatment Difference vs Placebo % (95% CI)^b
Primary Endpoints			
sPGA of 0/1	340 (83.5)	7 (7.0)	76.5 (70.4, 82.5) ^c
PASI 90	298 (73.2)	2 (2.0)	70.8 (65.7, 76.0) ^c
Secondary Endpoints			
sPGA of 0	189 (46.4)	1 (1.0)	44.8 (39.5, 50.0)
PASI 75	361 (88.7)	8 (8.0)	80.6 (74.5, 86.6)
PASI 100	192 (47.2)	1 (1.0)	45.5 (40.3, 50.8)

^a Non-responder imputation (NRI) was used to impute missing data

^b Treatment differences, 95% CIs and p-values were based on the Cochran-Mantel-Haenszel test stratified by weight (≤ 100 kg versus > 100 kg) and prior TNF exposure (0 versus ≥ 1). Type I error rate for the multiple endpoints was controlled using a pre-defined hierarchical testing procedure.

^c $p < 0.001$

Table 9 – Results at Week 52 and 104 (NRIa) in Adults with Plaque Psoriasis who were considered responders (achieved sPGA 0/1 at Week 28) and were re-randomized in IMMSTANCE

	Re-Randomized to Continue Skyrizi (N = 111) n (%)	Re-Randomized to Withdrawn (Placebo) (N = 225) n (%)
sPGA of 0/1		
Week 52	97 (87.4)	138 (61.3)
Week 104	90 (81.1)	16 (7.1)
sPGA of 0		
Week 52	72 (64.9)	69 (30.7)
Week 104	70 (63.1)	5 (2.2)

^a Non-responder imputation (NRI) was used to impute missing data

The results of the IMMVENT study are presented in **Table 10** and **Figure 1**.

Table 10 - Efficacy Results at Week 16 (NRIa) in Adults with Plaque Psoriasis in IMMVENT

	Skyrizi (N = 301) n (%)	Adalimumab (N = 304) n (%)	Treatment Difference vs Adalimumab % (95% CI)^b
Primary Endpoints			
sPGA of 0/1	252 (83.7)	183 (60.2)	23.3 (16.6, 30.1) ^c
PASI 90	218 (72.4)	144 (47.4)	24.9 (17.5, 32.4) ^c
Secondary Endpoints			
PASI 75	273 (90.7)	218 (71.7)	18.9 (13.0, 24.9)
PASI 100	120 (39.9)	70 (23.0)	16.7 (9.5, 23.9)

^a Non-responder imputation (NRI) was used to impute missing data

^b Treatment differences, 95% CIs and p-values were based on the Cochran-Mantel-Haenszel test stratified by weight (≤ 100 kg versus > 100 kg) and prior TNF exposure (0 versus ≥ 1). Type I error rate for the multiple endpoints was controlled using a pre-defined hierarchical testing procedure.

^c $p < 0.001$

Among the patients who had PASI 50 to $<$ PASI 90 with adalimumab at Week 16 and were re-randomized, 66.0% (35/53) and 39.6% (21/53) of patients re-randomized to Skyrizi achieved PASI 90 and PASI 100, respectively, compared with 21.4% (12/56) and 7.1% (4/56) who continued to receive adalimumab at Week 44.

Figure 1. Proportion of Patients Achieving of PASI 90 After Re-randomization in IMMVENT

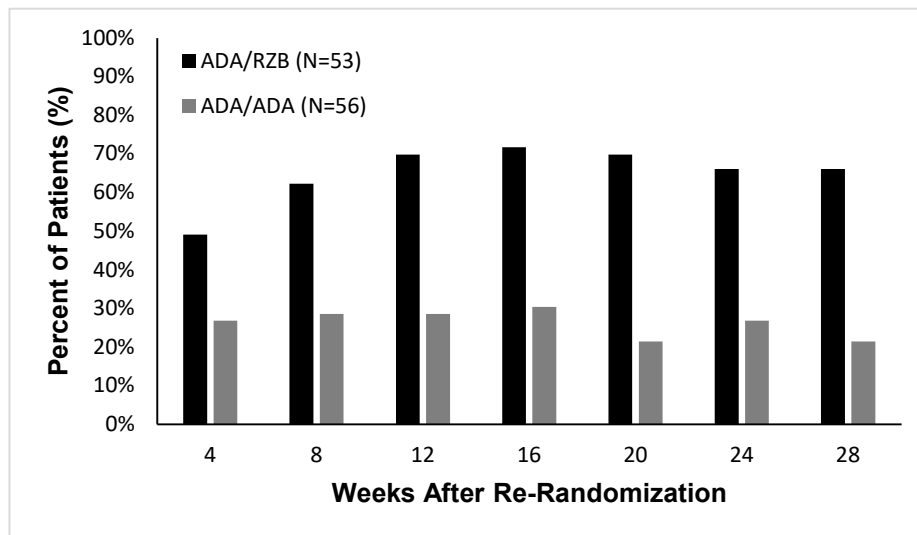

ADA/ADA: Patients randomized to adalimumab and continued adalimumab
 ADA/RZB: Patients randomized to adalimumab and switched to Skyrizi
 $p < 0.05$ at Week 4 and $p < 0.001$ at each time point beginning at Week 8
 RZB = risankizumab; ADA = adalimumab

Maintenance and Durability of Response

IMMHANCE patients originally on Skyrizi who were considered responders (achieved sPGA of 0/1 at Week 28) were re-randomized to continue Skyrizi every 12 weeks through Week 88 ($n = 111$) or were withdrawn from therapy ($n = 225$). Among patients who were considered responders and relapsed (sPGA ≥ 3) following withdrawal from Skyrizi, 83.7% (128/153) regained sPGA of 0/1 response after 16 weeks of re-treatment.

Loss of sPGA of 0/1 was observed as early as 12 weeks after a missed dose. Of those subjects who were re-randomized to withdraw from treatment, 80.9% (182/225) relapsed and the median time to relapse was 42 weeks. No characteristics were identified to predict the time to loss of response or likelihood of regaining response at the individual patient level.

Quality of Life/Patient-Reported Outcomes

In ULTIMMA-1 and ULTIMMA-2, the percentage of patients with Dermatology Life Quality Index (DLQI) of 0/1 (no impact on health-related quality of life) at Week 16 were 65.8% and 66.7%, respectively, in the Skyrizi groups, 7.8% and 4.1%, respectively, in the placebo groups, and 43.0% and 46.5%, respectively, in the ustekinumab groups.

In ULTIMMA-1 and ULTIMMA-2, psoriasis symptoms of itch, pain, redness, and burning were assessed with the Psoriasis Symptom Scale (PSS). In ULTIMMA-1 and ULTIMMA-2, 29.3% and 31.3% of patients, respectively, in the Skyrizi groups, and 2.0% and 0% of patients, respectively, in the placebo groups, reported a PSS total score of 0 at Week 16.

Psoriatic Arthritis

The safety and efficacy of Skyrizi were assessed in 1,407 patients in 2 randomized, double-blind, placebo-controlled studies (964 in KEEPSAKE1 and 443 in KEEPSAKE2) in patients 18 years and older with active PsA (**Table 11**).

Patients in these studies had a diagnosis of PsA for at least 6 months based on the Classification Criteria for Psoriatic Arthritis (CASPAR), a median duration of PsA of 4.9 years at baseline, ≥ 5 tender joints and ≥ 5 swollen joints, and active plaque psoriasis or nail psoriasis at baseline. 55.9% of patients had $\geq 3\%$ BSA with active plaque psoriasis. 63.4% and 27.9% of patients had enthesitis and dactylitis, respectively. In KEEPSAKE1 where nail psoriasis was further assessed, 67.3% had nail psoriasis.

In KEEPSAKE1, all patients had a previous inadequate response or intolerance to non-biologic DMARD therapy and were biologic naïve. In KEEPSAKE2, 53.5% of patients had a previous inadequate response or intolerance to non-biologic DMARD therapy and 46.5% of patients had a previous inadequate response or intolerance to biologic therapy.

In both studies, 59.6% of patients received concomitant methotrexate (MTX), 11.6% received concomitant non-biologic DMARDs other than MTX, and 28.9% received Skyrizi monotherapy.

In both studies, patients were randomized to receive Skyrizi 150 mg or placebo at Weeks 0, 4, and 16. Starting from Week 28, all patients received Skyrizi every 12 weeks.

The primary endpoint was the proportion of patients who achieved an American College of Rheumatology (ACR) 20 response at Week 24.

Table 11 – Summary of Patient Demographics for Clinical Trials in Psoriatic Arthritis

Study #	Trial Design	Dosage, Route of Administration, and Schedule ^a	Number of Patients	Mean Age (SD) (Range) Years	Sex n (%)
KEEPSAKE 1	Phase 3, randomized, double-blind, placebo-controlled. <ul style="list-style-type: none"> Patients have had an inadequate response or intolerance to at least 1 non-biologic DMARD. 	RZB 150 mg SC Wks 0, 4, then q12w PBO SC Wks 0, 4, 16 then RZB 150 mg SC at Wk 24, 28 and q12w	Total: N=964 RZB: 483 PBO: 481	51.3 (12.15) (20, 85)	Female: 478 (49.6) Male: 486 (50.4)

Study #	Trial Design	Dosage, Route of Administration, and Schedule ^a	Number of Patients	Mean Age (SD) (Range) Years	Sex n (%)
KEEPSAKE 2	Phase 3, randomized, double-blind, placebo-controlled. <ul style="list-style-type: none"> Patients have had an inadequate response or intolerance to 1 or 2 biologics and/or at least 1 non-biologic DMARD. 	RZB 150 mg SC Wks 0, 4, then q12w PBO SC Wks 0, 4, 16 then RZB 150 mg SC at Wk 24, 28 and q12w	Total: N=443 RZB: 224 PBO: 219	52.9 (12.57) (23, 84)	Female: 244 (55.1) Male: 199 (44.9)

SC = subcutaneous; PBO = placebo; RZB = risankizumab; q12w = every 12 weeks; wk = week

a. Detailed information about dosage, route of administration and duration of these clinical trials are included above in this section.

In both Psoriatic Arthritis studies (KEEPSAKE 1 and KEEPSAKE 2), treatment with Skyrizi resulted in clinically meaningful improvements in measures of disease activity compared with placebo at Week 24.

Time to onset of efficacy was rapid across measures with greater responses versus placebo seen as early as Week 4 in 25.7% and 19.6% of patients for ACR20 for KEEPSAKE1 and KEEPSAKE2, respectively.

In both studies, similar responses were seen regardless of concomitant non-biologic DMARD use, number of prior non biologic DMARDs, age, gender, race, and BMI. In KEEPSAKE2, responses were seen regardless of prior biologic therapy.

Table 12 – Efficacy Results in Studies KEEPSAKE1 and KEEPSAKE 2

Endpoint	KEEPSAKE1		KEEPSAKE2	
	Placebo N=481 n (%)	Skyrizi N=483 n (%)	Placebo N=219 n (%)	Skyrizi N=224 n (%)
ACR20 Response				
Week 16	161 (33.4)	272 (56.3) ^a	55 (25.3)	108 (48.3) ^a
Week 24	161 (33.5)	277 (57.3) ^a	58 (26.5)	115 (51.3) ^a
ACR50 Response				
Week 24	54 (11.3)	162 (33.4)	20 (9.3)	59 (26.3)
ACR70 Response				
Week 24	23 (4.7)	74 (15.3)	13 (5.9)	27 (12.0)
Minimal Disease Activity (MDA) Response				
Week 24	49 (10.2)	121 (25.0) ^a	25 (11.4)	57 (25.6) ^a

a. multiplicity-controlled $p \leq 0.001$ risankizumab vs placebo comparison

Dactylitis and Enthesitis

In an analysis of pooled data from studies KEEPSAKE1 and KEEPSAKE 2, 48.4% vs 34.8% of patients treated with Skyrizi vs placebo had resolution of enthesitis (LEI=0) at Week 24, and 68.1% vs 51.0% of patients treated with Skyrizi vs placebo had resolution of dactylitis (LDI=0) at Week 24.

Maintenance of Response

An analysis of observed data at Week 52 suggested that the ACR20, ACR50, and ACR70 responses, MDA, enthesitis resolution, and dactylitis resolution in studies KEEPSAKE1 and KEEPSAKE 2 were maintained at Week 52.

In both studies, improvements were shown in all components of the ACR scores including subject's assessment of pain (see **Table 13**).

Table 13 – Mean Change from Baseline in ACR Components

	KEEPSAKE1		KEEPSAKE2	
	Placebo (N=481) Mean (SD)	SKYRIZI (N=483) Mean (SD)	Placebo (N=219) Mean (SD)	SKYRIZI (N=224) Mean (SD)
Number of Swollen Joints (0-66)				
Baseline	12.2 (8.0)	12.1 (7.8)	13.6 (9.0)	13.0 (8.7)
Mean change at Week 24	-6.7 (7.2)	-8.7 (7.2)	-6.5 (7.8)	-9.1 (7.6)
Number of Tender Joints (0-68)				
Baseline	20.5 (12.8)	20.8 (14.0)	22.3 (13.8)	22.8 (14.9)
Mean change at Week 24	-7.9 (10.7)	-12.0 (12.3)	-8.3 (11.3)	-13.0 (12.5)
Patient's Assessment of Pain ^a				
Baseline	57.1 (22.6)	57.1 (22.6)	57.0 (23.1)	55.0 (23.5)
Mean change at Week 24	-10.9 (25.4)	-21.4 (26.5)	-8.7 (25.3)	-15.3 (26.5)
Patient's Global Assessment ^a				
Baseline	57.4 (22.1)	57.9 (21.7)	56.2 (23.0)	56.2 (21.8)
Mean change at Week 24	-11.1 (25.1)	-22.6 (26.9)	-8.7 (25.4)	-17.7 (27.7)
Physician Global Assessment ^a				
Baseline	62.4 (17.0)	61.3 (17.6)	60.7 (16.4)	63.0 (17.0)
Mean change at Week 24	-22.2 (22.8)	-34.8 (23.2)	-21.3 (25.2)	-35.5 (25.6)
Health Assessment Questionnaire - Disability Index (HAQ-DI) ^b				
Baseline	1.2 (0.7)	1.2 (0.7)	1.1 (0.6)	1.1 (0.6)
Mean change at Week 24	-0.1 (0.5)	-0.3 (0.5)	-0.1 (0.4)	-0.2 (0.5)
High sensitivity C-reactive protein (hs-CRP) mg/L				
Baseline	11.3 (14.1)	11.9 (15.9)	8.2 (17.1)	7.4 (10.9)

	KEEPSAKE1		KEEPSAKE2	
	Placebo (N=481) Mean (SD)	SKYRIZI (N=483) Mean (SD)	Placebo (N=219) Mean (SD)	SKYRIZI (N=224) Mean (SD)
Mean change at Week 24	-0.2 (11.7)	-4.3 (12.8)	-0.5 (14.5)	-1.8 (13.4)

SD= Standard Deviation.

- Assessment based on Visual Analog Scale (100 mm) with the left end indicating “no pain” (for patient’s assessment of pain), “very well” (for patient global assessment), or “no arthritis activity” (for physician global assessment) and the right end indicating “the worst possible pain” (for patient assessment of pain), “poor” (for patient global assessment), or “extremely active arthritis” (for physician global assessment).
- Disability Index of the Health Assessment Questionnaire; 0 = no difficulty to 3 = inability to perform, measures the patient’s ability to perform the following: dressing, arising, eating, walking, hygiene, reaching, gripping, and activities of daily living.

Skin Psoriasis

Among the subset of patients with BSA \geq 3% at Baseline, a greater percentage of patients in the risankizumab vs. placebo arms of studies KEEPSAKE1 and KEEPSAKE2 achieved PASI 100 response at Week 24. Subjects in the risankizumab arms of both studies also demonstrated greater improvements in BSA-PsO at Week 24.

Nail Psoriasis

Treatment with Skyrizi resulted in improvement in nail psoriasis as measured by modified Nail Psoriasis Severity Index (mNAPSI) and the 5-point Physician’s Global Assessment of Fingernail Psoriasis (PGA-F) in patients with nail psoriasis (67.3%) at baseline in KEEPSAKE1 (see **Table 14**).

Table 14 – Nail Psoriasis Efficacy Results in KEEPSAKE1

	placebo N=338	Skyrizi N=309
mNAPSI change from baseline^b		
Week 24	-5.57	-9.76 ^a
PGA-F change from baseline^b		
Week 24	-0.4	-0.8 ^a
PGA-F clear/minimal and \geq2-grade improvement^c		
Week 24 n (%)	30 (15.9)	71 (37.8)

- multiplicity-controlled $p \leq 0.001$ Skyrizi vs placebo comparison
- Summarized for patients with baseline nail psoriasis (Placebo N=338; Skyrizi N=309)
- Summarized for patients with nail psoriasis and a PGA-F overall global assessment score of 'Mild', 'Moderate' or 'Severe' at Baseline (Placebo N=190; risankizumab N=188).

Radiographic Response

In Study KEEPSAKE1, inhibition of progression of structural damage was assessed radiographically and expressed as the change in modified Total Sharp Score (mTSS) at Week 24, compared with baseline. The mTSS score was modified for psoriatic arthritis by addition of hand distal interphalangeal (DIP) joints. Skyrizi numerically reduced the mean progression of structural damage at Week 24 compared with placebo (mean change from baseline in mTSS score was 0.23 in the Skyrizi group compared with 0.32 in the placebo group). The proportion of patients with no radiographic progression (defined as a change from baseline in mTSS ≤ 0) was higher with Skyrizi (92.4%) compared with placebo (87.7%) at Week 24.

Physical Function and Health Related Quality of Life

In KEEPSAKE1 and KEEPSAKE2, physical function and disability were assessed by the Health Assessment Questionnaire-Disability Index (HAQ-DI), 36-Item Short Form Health Survey (SF-36) V2. Fatigue was assessed using Functional Assessment of Chronic Illness Therapy Fatigue Scale (FACIT-Fatigue).

In KEEPSAKE 1, patients treated with Skyrizi showed improvement from baseline in physical function as assessed by HAQ-DI at Week 24 (-0.31) compared with placebo (-0.11) (p-value ≤ 0.001). In KEEPSAKE 2, patients treated with Skyrizi showed improvement from baseline in HAQ-DI at Week 24 (-0.22) compared with placebo (-0.05) (p-value ≤ 0.001). In both studies, a greater proportion of patients achieved a clinically meaningful reduction of at least 0.35 in HAQ-DI score from baseline in the Skyrizi group compared with placebo at Week 24.

In both studies at Week 24, patients treated with Skyrizi also demonstrated improvements in the SF-36 V2 physical component summary scores and in FACIT-Fatigue scores compared with patients who received placebo.

At baseline, psoriatic spondylitis was reported in 19.6% and 19.6% of patients in KEEPSAKE1 and KEEPSAKE2, respectively. Patients with psoriatic spondylitis who were treated with Skyrizi showed improvements from baseline in Bath Ankylosing Spondylitis Disease Activity Index (BASDAI) and Ankylosing Spondylitis Disease Activity (ASDAS) scores compared with placebo at Week 24.

Crohn's Disease

The efficacy and safety of risankizumab was assessed in 1419 subjects with moderately to severely active Crohn's disease in three multicentre, randomised, double-blind, placebo-controlled clinical studies. Enrolled subjects were 16 years of age or older with a Crohn's Disease Activity Index (CDAI) of 220 to 450, an average daily stool frequency (SF) ≥ 4 and/or average daily abdominal pain score (APS) ≥ 2 , and a Simple Endoscopic Score for CD (SES-CD) of ≥ 6 , or ≥ 4 for isolated ileal disease, excluding the narrowing component and confirmed by a central reviewer.

ADVANCE and MOTIVATE were 12-week induction studies that evaluated the ability of risankizumab administered by intravenous (IV) injection to achieve CD-related clinical, endoscopic, and quality of life changes. FORTIFY was a 52-week maintenance study that similarly evaluated risankizumab administered by subcutaneous (SC) injection in subjects who achieved clinical response ($\geq 30\%$ decrease in SF and/or $\geq 30\%$ decrease in APS and both not worse than baseline) after 12 weeks of risankizumab IV treatment in the induction studies.

Table 15 - Summary of Subject Demographics for Clinical Trials in Crohn's Disease

Study #	Trial Design	Dosage, Route of Administration, and Schedule ^a	Number of Study Subjects	Mean Age (Range) Years	Sex n (%)
ADVANCE	Phase 3, randomized, PBO-controlled, DB, parallel study in subjects who failed prior biologic or conventional therapy	RZB 600 mg IV Wks 0, 4, and 8 RZB 1200 mg IV Wks 0, 4, and 8 PBO IV Wks 0, 4, and 8	RZB 600 mg: 336 RZB 1200 mg: 339 PBO: 175	37.5 (16, 79)	Female 390 (46) Male 460 (54)
MOTIVATE	Phase 3, randomized, PBO-controlled, DB, parallel study in subjects who failed prior biologic therapy	RZB 600 mg IV Wks 0, 4, and 8 RZB 1200 mg IV Wks 0, 4, and 8 PBO IV Wks 0, 4, and 8	RZB 600 mg: 191 RZB 1200 mg: 191 PBO: 187	39.6 (16, 80)	Female 276 (49) Male 293 (51)
FORTIFY	Phase 3, randomized, DB, PBO-controlled study for subjects who responded to induction treatment with Skyrizi in either ADVANCE or MOTIVATE.	RZB 360 mg SC q8w RZB 180 mg SC q8w PBO SC q8w for up to 52 weeks	RZB 360 mg: 141 RZB 180 mg: 157 Withdrawal/PBO ^a : 164	38.1 (16, 76)	Female 224 (48) Male 238 (52)

a. Subjects achieved clinical response in ADVANCE or MOTIVATE following 12 weeks of induction with IV risankizumab and received placebo SC in FORTIFY as maintenance regimen (withdrawal).

DB = double blind; IV = intravenous; SC = subcutaneous; PBO = placebo; RZB = risankizumab; q8w = every 8 weeks; wk = week

ADVANCE and MOTIVATE

In studies ADVANCE and MOTIVATE, subjects were randomized to receive either Skyrizi 600 mg IV, Skyrizi 1200 mg IV, or placebo at Week 0, Week 4, and Week 8. The Skyrizi 1200 mg dose did not demonstrate additional treatment benefit relative to the 600 mg dose and is not a recommended induction regimen.

In ADVANCE, 58% (491/850) of subjects had failed or were intolerant to prior treatment with one or more biologic therapies (prior biologic failure), and 42% (359/850) of subjects had failed or were intolerant to treatment with conventional therapy but not to biologic therapy (without prior biologic failure). In ADVANCE, among the subjects without prior biologic failure, 87% (314/359) were naïve to biologic treatment; the remaining 13% had received biologic therapy but neither failed nor demonstrated intolerance. All subjects in MOTIVATE had prior biologic failure. At baseline, 32% and 23% of subjects were taking concomitant corticosteroids and/or immunomodulators, respectively.

The co-primary endpoints were SF/APS clinical remission and endoscopic response, both assessed at Week 12. SF/APS clinical remission was defined as SF \leq 2.8 and APS \leq 1, neither worse than baseline. Endoscopic response was defined as greater than 50% decrease in SES-CD from baseline, or a decrease of at least 2 points for subjects with a baseline score of 4 and isolated ileal disease. In both studies, a greater proportion of subjects receiving Skyrizi achieved clinical remission and endoscopic response at Week 12 compared to placebo. Key secondary endpoints measured at Week 12 included the proportion of subjects with CDAI clinical remission, endoscopic remission, and CDAI clinical response, which consistently favoured Skyrizi compared to placebo (Table 16).

Table 16 - Results of Key Efficacy Endpoints at Week 12 in Subjects with Crohn’s Disease in Studies ADVANCE and MOTIVATE

	ADVANCE			MOTIVATE		
	Skyrizi 600 mg IV (N = 336) %	Placebo IV (N = 175) %	Adjusted ^a Treatment Difference % (95% CI)	Skyrizi 600 mg IV (N = 191) %	Placebo IV (N = 187) %	Adjusted ^a Treatment Difference % (95% CI)
Co-primary endpoints						
Clinical remission (SF/APS)	43%	22%	22% [14%, 30%] ^b	35%	19%	15% [6%, 24%] ^b
Endoscopic response	40%	12%	28% [21%, 35%] ^b	29%	11%	18% [10%, 25%] ^b
Key secondary endpoints						
Clinical remission (CDAI) ^c	45%	25%	21% [12%, 29%] ^b	42%	20%	22% [13%, 31%] ^b
Endoscopic remission ^d	24%	9%	15% [9%, 21%] ^b	19%	4%	15% [9%, 21%] ^b
Clinical response (CDAI) ^e	60%	37%	23% [14%, 32%] ^b	60%	30%	29% [20%, 39%] ^b

	ADVANCE			MOTIVATE		
	Skyrizi 600 mg IV (N = 336) %	Placebo IV (N = 175) %	Adjusted^a Treatment Difference % (95% CI)	Skyrizi 600 mg IV (N = 191) %	Placebo IV (N = 187) %	Adjusted^a Treatment Difference % (95% CI)

- a. Based on Cochran-Mantel-Haenszel method adjusted for randomization stratification factors
- b. Statistically significant under multiplicity control for Skyrizi vs placebo comparison ($p < 0.05$)
- c. CDAI < 150 at Week 12
- d. SES-CD ≤ 4 and at least a 2-point reduction versus Baseline and no subscore greater than 1 in any individual variable
- e. A decrease of at least 100 points from baseline in CDAI

Clinical response and clinical remission were observed at Week 4 in greater proportions of subjects receiving Skyrizi than placebo.

In ADVANCE and MOTIVATE, a greater proportion of subjects receiving Skyrizi (21% and 14%, respectively) compared to placebo (8% and 4%, respectively) demonstrated an absence of ulceration at Week 12 (SES-CD ulcerated surface subscore of 0 in subjects with a subscore ≥ 1 at Baseline).

In ADVANCE, in subjects receiving Skyrizi who had prior biologic failure (N=195), 41% demonstrated SF/APS clinical remission and 33% demonstrated endoscopic response at Week 12, compared with 23% and 11%, respectively, receiving placebo (N=97). In subjects receiving Skyrizi who had prior conventional therapy failure, but without prior biologic failure (N=141), 48% demonstrated SF/APS clinical remission and 50% demonstrated endoscopic response at Week 12, compared with 21% and 13%, respectively, receiving placebo (N=78).

In ADVANCE and MOTIVATE, least squared mean change from baseline in Inflammatory Bowel Disease Questionnaire (IBDQ) score at Week 12 was 44.3 and 39.6 in subjects receiving Skyrizi, and 23.6 and 27.2 in subjects receiving placebo; least squared mean change from baseline in Functional Assessment of Chronic Illness Therapy Fatigue (FACIT-F) score at Week 12 was 11.2 and 10.5 in subjects receiving Skyrizi, and 6.0 and 7.7 in subjects receiving placebo.

FORTIFY

FORTIFY evaluated 462 subjects who achieved SF/APS clinical response after 12 weeks of Skyrizi IV treatment in the induction studies ADVANCE and MOTIVATE. SF/APS clinical response was defined as $\geq 30\%$ decrease in average daily SF and/or $\geq 30\%$ decrease in average daily APS and both not worse than baseline of the induction regimen study. Subjects were randomized to receive a maintenance regimen of Skyrizi 360 mg SC, Skyrizi 180 mg SC, or placebo SC every 8 weeks for up to 52 weeks. The Skyrizi 180 mg SC dose did not demonstrate consistent treatment benefit relative to placebo and is not a recommended maintenance regimen.

The co-primary endpoints were SF/APS clinical remission and endoscopic response, both assessed at Week 52. Co-primary endpoints were also measured in subjects with and without prior biologic failure.

A greater proportion of subjects receiving Skyrizi achieved clinical remission and endoscopic response at Week 52 compared to placebo. Key secondary endpoints measured at Week 52 included the proportion of subjects with CDAI clinical remission, endoscopic remission, ulcer-free endoscopy (mucosal healing), and CDAI clinical response (Table 17).

Table 17 - Results of Key Efficacy Endpoints at Week 52 in Subjects with Crohn’s Disease in Study FORTIFY

	Skyrizi IV Induction/ Placebo ^a (N = 164) %	Skyrizi IV Induction/ Skyrizi 360 mg SC (N = 141) %	Adjusted ^b Treatment Difference % (95% CI)
Co-primary endpoints			
Clinical remission (SF/APS)	40%	52%	15% [5%, 25%] ^c
Endoscopic response	22%	47%	28% [19%, 37%] ^c
Key secondary endpoints			
Clinical remission (CDAI)	41%	52%	15% [4%, 25%]
Endoscopic remission	13%	39%	28% [20%, 37%]
Clinical response (CDAI)	48%	62%	16% [6%, 27%]

- a. Includes subjects who achieved clinical response after 12 weeks of risankizumab IV treatment in the induction studies ADVANCE or MOTIVATE, and were randomized to receive placebo (i.e., withdrawal) as maintenance regimen in FORTIFY.
- b. Based on Cochran-Mantel-Haenszel method adjusted for randomization stratification factors.
- c. Statistically significant under multiplicity control for Skyrizi vs placebo comparison ($p < 0.05$).

In FORTIFY, in subjects receiving Skyrizi who had prior biologic failure (N=102), 48% demonstrated SF/APS clinical remission and 44% demonstrated endoscopic response at Week 52, compared with 34% and 20%, respectively, receiving placebo (N=123). In subjects receiving Skyrizi who had prior conventional therapy failure, but without prior biologic failure (N=39), 62% demonstrated SF/APS clinical remission and 54% demonstrated endoscopic response at Week 52, compared with 56% and 27%, respectively, receiving placebo (N=41).

Maintenance of clinical remission (clinical remission at Week 52 among subjects with clinical remission at Week 0 of FORTIFY) was observed in 69% of subjects treated with Skyrizi 360 mg SC (N=72) and 51% of subjects treated with placebo (N=91).

15 MICROBIOLOGY

Not applicable.

16 NON-CLINICAL TOXICOLOGY

General Toxicology:

In a 26-week repeat-dose toxicity study in cynomolgus monkeys, risankizumab was well-tolerated at weekly doses up to 50 mg/kg. There were no risankizumab-related adverse effects observed, including on cardiovascular, respiratory, and nervous system functions. At the no-observed-adverse-effect level (NOAEL) of 50 mg/kg once weekly, the AUC was approximately 69-fold higher than the AUC for psoriasis patients following the first two 150 mg doses at Weeks 0 and 4 (622 mcg•day/mL). For Crohn's disease, these doses in the 26-week chronic study in cynomolgus monkeys produced exposures 7 times the clinical exposures during induction at a dose of 600 mg IV every 4 weeks and 28 times the clinical exposures for maintenance when given 360 mg SC every 8 weeks.

Carcinogenicity:

Carcinogenicity studies have not been conducted with risankizumab.

Genotoxicity:

Genotoxicity studies have not been conducted with risankizumab.

Reproductive and Developmental Toxicology:

In an enhanced pre- and post-natal development toxicity study, pregnant cynomolgus monkeys (21, 22, and 21 in the 0, 5 and 50 mg/kg groups, respectively) were administered weekly subcutaneous doses of risankizumab from the beginning of organogenesis to parturition. Neonatal deaths occurred in the offspring of 1 of 18 control monkeys, 2 of 17 low-dose monkeys, and 3 of 15 high-dose monkeys (AUC_{0-24h} values were 13- and 99-fold greater, respectively, than the human exposure levels in plaque psoriasis patients and, in Crohn's disease patients, 1.24- to 10-fold greater than human exposure levels during induction at a dose of 600 mg IV every 4 weeks and 5- to 39-fold greater than human exposure levels during maintenance when given 360 mg SC every 8 weeks). These neonatal deaths were attributed to maternal neglect, trauma, and/or early or late delivery, although, a drug-related effect could not be ruled out. An increase in the fetal loss rate (spontaneous abortions, including stillbirths) was also observed at both dose levels. While the incidence rate for fetal loss in each dose group was within the historical control range for the testing facility, a drug-related effect could not be ruled out. The clinical significance of these findings is unknown. No risankizumab-related adverse effects, including any effects on neurobehavioural or immunological development, were observed in surviving infants from birth through 6 months of age.

In the infants, mean serum concentrations increased in a dose-dependent manner and were approximately 20 to 90% of the respective maternal concentrations. Following delivery, most maternal animals and all infants from the risankizumab-administered groups had measurable serum concentrations of risankizumab up to 91 days postpartum. Serum concentrations were below detectable levels at 180 days postpartum in all infants and in all but one maternal animal.

No dedicated fertility studies have been conducted in animals however, in the 26-week repeat-dose toxicity study, histopathology of reproductive organs from female cynomolgus monkeys did not show any relevant adverse finding. In addition, in a separate 26-week repeat dose study conducted in sexually mature male cynomolgus monkeys, no adverse effects on male fertility-related parameters were observed at a dose of 50 mg/kg (98-fold greater than the human exposure level in plaque psoriasis patients and, in Crohn's disease patients, 10-fold greater than human exposure levels during

induction at a dose of 600 mg IV every 4 weeks and 39-fold greater than human exposure levels during maintenance when given 360 mg SC every 8 weeks). Specifically, there were no risankizumab-related adverse effects on testicular volume, semen analysis (total sperm count, sperm concentration, sperm motility, and sperm morphology), serum testosterone concentration, reproductive organ weights, or histopathological findings in reproductive organs.

Juvenile Toxicity:

Juvenile toxicity studies have not been conducted with risankizumab.

PATIENT MEDICATION INFORMATION

READ THIS FOR SAFE AND EFFECTIVE USE OF YOUR MEDICINE

PrSKYRIZI®

150 mg/mL risankizumab injection, solution for subcutaneous injection

Read this carefully before you start taking Skyrizi and each time you get a refill. This leaflet is a summary and will not tell you everything about this drug. Talk to your healthcare professional about your medical condition and treatment and ask if there is any new information about Skyrizi.

What is Skyrizi used for?

- Skyrizi is a prescription medicine used to treat adults with moderate to severe plaque psoriasis, an inflammatory condition affecting the skin and nails. Plaque psoriasis can cause raised, thick, red and scaly patches (“psoriatic lesions”) that can appear anywhere on your body.
- Skyrizi is used to treat adults with active psoriatic arthritis. Psoriatic arthritis is an inflammatory disease of the joints, usually accompanied by psoriasis. Psoriatic arthritis can cause pain, swelling and stiffness in the joints, in addition to a disruption in daily activities and fatigue. If you have active psoriatic arthritis, you will be given Skyrizi alone or in combination with a conventional Disease Modifying Anti-Rheumatic Drug (DMARD), such as methotrexate.
- Skyrizi is used to treat adults with moderate to severe Crohn’s disease, an inflammatory condition affecting the gastrointestinal tract that can cause abdominal pain, severe diarrhea, fatigue, and even weight loss.

How does Skyrizi work?

Skyrizi contains the active substance risankizumab. This medicine works by stopping a protein in the body called IL-23, which causes inflammation.

Plaque Psoriasis

Skyrizi reduces inflammation and can therefore help to improve skin clearance and to reduce symptoms of psoriasis such as burning, itching, pain, and redness.

Psoriatic Arthritis

Skyrizi reduces the inflammation and can therefore help to reduce pain, stiffness, and swelling in and around your joints, pain and stiffness in your spine, psoriatic skin rash, psoriatic nail damage, and it may limit damage to the bone and cartilage in your joints. These effects can ease your normal daily activities, reduce tiredness, and improve your quality of life.

Crohn’s Disease

Skyrizi reduces the inflammation and can therefore help to reduce the signs and symptoms of your disease like abdominal pain, severe diarrhea, fatigue, and even weight loss.

If you have active Crohn’s disease you may first be given other medicines. If these medicines do not work well enough, you will be given Skyrizi to treat your Crohn’s disease.

What are the ingredients in Skyrizi?

Medicinal ingredient: risankizumab

Non-medicinal ingredients: acetic acid, polysorbate 20, sodium acetate trihydrate, trehalose dihydrate, and water for injection

Skyrizi comes in the following dosage forms:

Plaque Psoriasis and Psoriatic Arthritis

Pre-filled pen and pre-filled syringe with 150 mg of risankizumab in 1 mL of solution for injection (150 mg/mL).

Skyrizi 150 mg/mL is a clear and colourless to yellow liquid in a pre-filled pen or pre-filled syringe with needle guard. Each carton contains 1 pre-filled pen or 1 pre-filled syringe.

Crohn's Disease

Vial with 600 mg of risankizumab in 10 mL of solution for infusion (60 mg/mL). Skyrizi 60 mg/mL is a clear and colourless to slightly yellow liquid in a single-use vial. Each carton contains 1 vial.

Pre-filled cartridge with 360 mg of risankizumab in 2.4 mL of solution for subcutaneous injection (150 mg/mL). Skyrizi 150 mg/mL is a clear and colourless to yellow liquid in a pre-filled cartridge. Each carton contains 1 pre-filled cartridge with 1 on-body injector.

Do not use Skyrizi if:

- You have had a serious allergic reaction to risankizumab or any of the other ingredients of Skyrizi (See **What are the ingredients in Skyrizi?**). Symptoms of serious allergic reactions include: trouble breathing, feeling faint or dizzy, or swelling of your lips, tongue, or throat.
- If any of these symptoms occur during treatment with Skyrizi, stop taking Skyrizi and get emergency medical help right away.

To help avoid side effects and ensure proper use, talk to your healthcare professional before you take Skyrizi. Talk about any health conditions or problems you may have, including if you:

- currently have an infection or if you have an infection that keeps coming back. Skyrizi may lower your ability to fight infections and may increase your risk of infections.
- have tuberculosis (TB) or have been in close contact with someone with TB.
- have recently received or plan to receive an immunization (vaccine). You should not be given certain types of vaccines (called 'live vaccines') while using Skyrizi.

Talk to your healthcare professional right away if you have any of the symptoms of serious infection:

- fever, flu-like symptoms, night sweats
- feeling tired or short of breath
- cough
- blood in your phlegm (mucus)
- warm, red or painful skin, sores on your body different from your psoriasis, or a painful skin rash with blisters
- muscle aches
- weight loss

Talk to your healthcare professional right away if you have any of the signs or symptoms of an allergic reaction, including:

- difficulty breathing or swallowing
- swelling of the face, lips, tongue or throat
- severe itching of the skin, with a red rash or raised bumps

Other warnings you should know about:

Skyrizi is not approved for children and adolescents with plaque psoriasis, psoriatic arthritis or Crohn's disease under 18 years of age. This is because it has not been studied in this age group.

If you are pregnant, think you may be pregnant or are planning to have a baby, ask your doctor for advice before using this medicine. This is because it is not known if Skyrizi can harm your unborn baby. If you are a woman of childbearing potential, use adequate contraception while using Skyrizi and for at least 20 weeks after the last Skyrizi dose. Talk to your doctor about your contraception options.

If you are breastfeeding or are planning to breastfeed, talk to your doctor before using this medicine. It is not known if Skyrizi passes into breast milk. You and your doctor should decide if you will breastfeed while using Skyrizi.

Tell your healthcare professional about all the medicines you take, including any drugs, vitamins, minerals, natural supplements or alternative medicines.

How to take Skyrizi:

- Always use this medicine exactly as your doctor, pharmacist or nurse has told you. Check with your doctor, pharmacist or nurse if you are not sure how to use this medicine.
- Skyrizi is injected under your skin (called "subcutaneous injection") or given by your doctor through a vein in the arm (called "intravenous infusion").
- You and your doctor, pharmacist or nurse will decide if you should inject Skyrizi yourself. Do not inject yourself with this medicine unless you have been trained by your doctor, pharmacist or nurse. A caregiver may also give your injections after training. The AbbVie Care Support Program is also available to you if you require assistance with injections should you prefer nurse-administered injections. Information about the support services can be obtained by calling the AbbVie Care Support Program at 1-866-848-6472.
- For the pre-filled pen, take the carton out of the refrigerator and leave it at room temperature, out of direct sunlight, for **30 to 90 minutes** before injecting.
- For a more comfortable injection with the pre-filled syringe, take the carton out of the refrigerator and leave it at room temperature, out of direct sunlight, for **15 to 30 minutes** before injecting.
- For the pre-filled cartridge, take the carton out of the refrigerator and leave it at room temperature, out of direct sunlight, for **45 to 90 minutes** before injecting.
- Read the "**Instructions for Use**" before injecting Skyrizi yourself.

Usual dose:

Adults with Plaque Psoriasis and Psoriatic Arthritis

The dose is 150 mg given as one 150 mg injection. After the first dose, you will have the next dose 4 weeks later, and then every 12 weeks.

Do not stop using Skyrizi without talking to your doctor first. If you stop treatment, your symptoms may come back.

Adults with Crohn’s disease

You will begin treatment with Skyrizi with a starting dose which will be given by your doctor through a drip in your arm (intravenous infusion) over at least 60 minutes (refer to the Patient Medication Information for 60 mg/mL risankizumab for injection for intravenous infusion).

Starting doses

	How much?	When?
Starting doses	600 mg	When your doctor tells you
	600 mg	4 weeks after 1 st dose
	600 mg	4 weeks after 2 nd dose

Afterwards, you will receive or you will inject yourself Skyrizi as an injection under your skin (subcutaneous injection) using an on-body injector with pre-filled cartridge.

Maintenance doses

	How much?	When?
1 st maintenance dose	360 mg	4 weeks after the last starting dose (at Week 12)
Further doses	360 mg	Every 8 weeks, starting after the 1 st maintenance dose

Overdose:

If you think you, or a person you are caring for, have taken too much Skyrizi, contact your healthcare professional, hospital emergency department or regional poison control centre immediately, even if there are no symptoms.

Missed dose:

If you forgot to take Skyrizi, inject a dose as soon as you remember. Then, take your next dose at your regular scheduled time. Talk to your doctor if you are not sure what to do.

What are possible side effects from using Skyrizi?

These are not all the possible side effects you may have when taking Skyrizi. If you experience any side effects not listed here, contact your doctor. Your doctor will decide if you can keep using Skyrizi.

Tell your doctor, pharmacist or nurse if you get any of the following side effects:

Very common: may affect more than 1 in 10 people

- upper respiratory infections with symptoms such as sore throat and stuffy nose

Common: may affect up to 1 in 10 people

- feeling tired
- fungal skin infection
- injection site reactions
- headache
- itching
- burning when you urinate or urinating more often than normal

Uncommon: may affect up to 1 in 100 people

- small raised red bumps on the skin

Serious side effects and what to do about them			
Symptom / effect	Talk to your healthcare professional		Stop taking drug and get immediate medical help
	Only if severe	In all cases	
Uncommon			
Serious Infections: Fever, flu-like symptoms, night sweats, cough, blood in your phlegm (mucus), warm, red or painful skin, muscle aches, weight loss		√	√

If you have a troublesome symptom or side effect that is not listed here or becomes bad enough to interfere with your daily activities, talk to your doctor, pharmacist or nurse.

Reporting Side Effects

You can report any suspected side effects associated with the use of health products to Health Canada by:

- Visiting the Web page on Adverse Reaction Reporting (<https://www.canada.ca/en/health-canada/services/drugs-health-products/medeffect-canada.html>) for information on how to report online, by mail or by fax; or
- Calling toll-free at 1-866-234-2345.

NOTE: Contact your health professional if you need information about how to manage your side effects. The Canada Vigilance Program does not provide medical advice.

Storage:

Keep this medicine out of reach and sight of children.

Do not use this medicine after the expiration date which is stated on the pen, syringe, or cartridge label and outer carton after 'EXP'.

Store in a refrigerator between 2 and 8 °C (36 and 46 °F). Do not freeze. Do not use if Skyrizi has been frozen.

Keep in the original carton in order to protect from light.

If needed, you may also store Skyrizi 150 mg/mL pre-filled pen or pre-filled syringe out of the refrigerator (up to a maximum of 25°C [77°F]) for up to 24 hours in the original carton to protect from light.

The liquid should look clear to yellow. The liquid may contain tiny white or clear particles. Do not use if liquid is cloudy or contains flakes or large particles.

This medicine is for single use only. Ask your doctor, pharmacist or nurse how to throw away used pens, syringes, and cartridges safely.

If you want more information about Skyrizi:

- Talk to your healthcare professional.
- Find the full product monograph that is prepared for healthcare professionals and includes this Patient Medication Information by visiting the Health Canada website (<https://www.canada.ca/en/health-canada/services/drugs-health-products/drug-products/drug-product-database.html>); the manufacturer's website (www.abbvie.ca), or by calling 1-888-704-8271.

This leaflet was prepared by AbbVie Corporation.

Last Revised: JAN 25, 2023

PATIENT MEDICATION INFORMATION

READ THIS FOR SAFE AND EFFECTIVE USE OF YOUR MEDICINE

PrSKYRIZI®

60 mg/mL risankizumab for injection, solution for intravenous infusion

Read this carefully before you start taking Skyrizi. This leaflet is a summary and will not tell you everything about this drug. Talk to your healthcare professional about your medical condition and treatment and ask if there is any new information about Skyrizi.

What is Skyrizi used for?

Skyrizi is a prescription medicine used to treat adults with moderate to severe Crohn's disease, an inflammatory condition affecting the gastrointestinal tract that can cause abdominal pain, severe diarrhea, fatigue, and even weight loss.

How does Skyrizi work?

Skyrizi contains the active substance risankizumab. This medicine works by stopping a protein in the body called IL-23, which causes inflammation.

Skyrizi reduces the inflammation and can therefore help to reduce the signs and symptoms of your disease like abdominal pain, severe diarrhea, fatigue, and even weight loss.

If you have active Crohn's disease you may first be given other medicines. If these medicines do not work well enough, you will be given Skyrizi to treat your Crohn's disease.

What are the ingredients in Skyrizi?

Medicinal ingredient: risankizumab

Non-medicinal ingredients: acetic acid, polysorbate 20, sodium acetate trihydrate, trehalose dihydrate, and water for injection

Skyrizi comes in the following dosage forms:

Vial with 600 mg of risankizumab in 10 mL of solution for infusion (60 mg/mL). Skyrizi 60 mg/mL is a clear and colourless to slightly yellow liquid in a single-use vial. Each carton contains 1 vial.

Do not use Skyrizi if:

- You have had a serious allergic reaction to risankizumab or any of the other ingredients of Skyrizi (**See What are the ingredients in Skyrizi?**). Symptoms of serious allergic reactions include: trouble breathing, feeling faint or dizzy, or swelling of your lips, tongue, or throat.
- If any of these symptoms occur during treatment with Skyrizi, stop taking Skyrizi and get emergency medical help right away.

To help avoid side effects and ensure proper use, talk to your healthcare professional before you take Skyrizi. Talk about any health conditions or problems you may have, including if you:

- currently have an infection or if you have an infection that keeps coming back. Skyrizi may lower your ability to fight infections and may increase your risk of infections.
- have tuberculosis (TB) or have been in close contact with someone with TB.

- have recently received or plan to receive an immunization (vaccine). You should not be given certain types of vaccines (called ‘live vaccines’) while using Skyrizi.

Talk to your healthcare professional right away if you have any of the symptoms of serious infection:

- fever, flu-like symptoms, night sweats
- feeling tired or short of breath
- cough
- blood in your phlegm (mucus)
- warm, red or painful skin, sores on your body
- muscle aches
- weight loss

Talk to your healthcare professional right away if you have any of the signs or symptoms of an allergic reaction, including:

- difficulty breathing or swallowing
- swelling of the face, lips, tongue or throat
- severe itching of the skin, with a red rash or raised bumps

Other warnings you should know about:

Skyrizi is not approved for children and adolescents with Crohn’s disease under 18 years of age. This is because it has not been studied in this age group.

If you are pregnant, think you may be pregnant or are planning to have a baby, ask your doctor for advice before using this medicine. This is because it is not known if Skyrizi can harm your unborn baby. If you are a woman of childbearing potential, use adequate contraception while using Skyrizi and for at least 20 weeks after the last Skyrizi dose. Talk to your doctor about your contraception options.

If you are breastfeeding or are planning to breastfeed, talk to your doctor before using this medicine. It is not known if Skyrizi passes into breast milk. You and your doctor should decide if you will breastfeed while using Skyrizi.

Tell your healthcare professional about all the medicines you are using, have recently used or might use, including any drugs, vitamins, minerals, natural supplements or alternative medicines.

How to take Skyrizi:

You will begin treatment with Skyrizi with a starting dose which will be given to you by a qualified healthcare professional intravenously (through a vein) over at least 60 minutes.

Usual dose:

Starting doses

	How much?	When?
Starting doses	600 mg	When your doctor tells you
	600 mg	4 weeks after 1 st dose
	600 mg	4 weeks after 2 nd dose

Afterwards, you will receive a different dose of Skyrizi as maintenance therapy by an injection under your skin (subcutaneous injection) using an on-body injector with pre-filled cartridge (refer to the Patient Medication Information for 150 mg/mL risankizumab injection for subcutaneous injection).

Maintenance doses

	How much?	When?
1st maintenance dose	360 mg	4 weeks after the last starting dose (at Week 12)
Further doses	360 mg	Every 8 weeks, starting after the 1 st maintenance dose

Overdose:

If you think you, or a person you are caring for, have taken too much Skyrizi, contact your healthcare professional, hospital emergency department or regional poison control centre immediately, even if there are no symptoms.

Missed dose:

If you forget or miss the appointment for any of your doses, contact your doctor to reschedule your appointment as soon as you remember.

Do not stop using Skyrizi without talking to your doctor first. If you stop treatment, your symptoms may come back.

If you have any further questions on the use of this medicine, ask your doctor, pharmacist, or nurse.

What are possible side effects from using Skyrizi?

These are not all the possible side effects you may feel when taking Skyrizi. If you experience any side effects not listed here, contact your doctor. Your doctor will decide if you can keep using Skyrizi.

Tell your doctor, pharmacist or nurse if you get any of the following side effects:

Very common: may affect more than 1 in 10 people

- upper respiratory infections with symptoms such as sore throat and stuffy nose

Common: may affect up to 1 in 10 people

- feeling tired
- fungal skin infection
- injection site reactions
- headache
- itching
- burning when you urinate or urinating more often than normal

Uncommon: may affect up to 1 in 100 people

- small raised red bumps on the skin

Serious side effects and what to do about them			
Symptom / effect	Talk to your healthcare professional		Stop taking drug and get immediate medical help
	Only if severe	In all cases	
Uncommon			
Serious Infections: Fever, flu-like symptoms, night sweats, cough, blood in your phlegm (mucus), warm, red or painful skin, muscle aches, weight loss		√	√
Liver problems: yellowing of the skin or eyes, dark urine, abdominal pain, nausea, vomiting, loss of appetite, itching		√	√

If you have a troublesome symptom or side effect that is not listed here or becomes bad enough to interfere with your daily activities, talk to your doctor, pharmacist or nurse.

Reporting Side Effects

You can report any suspected side effects associated with the use of health products to Health Canada by:

Visiting the Web page on [Adverse Reaction Reporting \(https://www.canada.ca/en/health-canada/services/drugs-health-products/medeffect-canada.html\)](https://www.canada.ca/en/health-canada/services/drugs-health-products/medeffect-canada.html) for information on how to report online, by mail or by fax; or

Calling toll-free at 1-866-234-2345.

NOTE: Contact your health professional if you need information about how to manage your side effects. The Canada Vigilance Program does not provide medical advice.

Storage (instructions for healthcare professionals only):

Skyrizi 600 mg concentrate for solution for infusion is given in a hospital or clinic and patients should not need to store or handle it.

Keep this medicine out of reach and sight of children.

Do not use this medicine after the expiration date which is stated on the vial label and outer carton after 'EXP'.

Store in a refrigerator between 2 and 8 °C (36 and 46 °F). Do not freeze. Do not use if Skyrizi has been frozen.

Keep in the original carton in order to protect from light.

Do not shake the Skyrizi vial. Prolonged vigorous shaking can damage the medicine.

The liquid should look clear to slightly yellow. The liquid may contain tiny white or clear particles. Do not use if liquid is cloudy or contains flakes or large particles.

The following information is intended for healthcare professionals only

Instructions for intravenous induction dosing regimen

1. Skyrizi should be prepared by a healthcare professional using aseptic technique prior to labeled expiry date.
2. Skyrizi medicinal product must be diluted before administration.
3. Skyrizi for intravenous administration must be diluted into an intravenous infusion bag or glass bottle containing 5% dextrose in water (D5W) (600 mg/10 mL in 100 mL, or 250 mL or 500 mL) to a final drug concentration of approximately 1.2 mg/mL to 6 mg/mL.
4. The solution in the vial and dilutions should not be shaken.
5. Once diluted, the solution can be stored (protected from direct and indirect light) at room temperature between 15 to 30°C (59 to 86°F) for administration within 8 hours (including the infusion period) or, refrigerated immediately for up to 20 hours between 2 and 8 °C (36 and 46 °F) for later administration. Once removed from the refrigerated storage, the diluted solution should be administered within 8 hours (including infusion period). Do not freeze.
6. Prior to the start of the intravenous infusion, the content of the infusion bag or glass bottle should be at room temperature.
7. Infuse the diluted solution over a period of at least one hour.
8. Skyrizi vial solution should not be administered concomitantly in the same intravenous line with other medicinal products.
9. Each vial is for single use only and any unused medicinal product or waste material should be disposed of in accordance with local requirements.

If you want more information about Skyrizi:

Talk to your healthcare professional.

Find the full product monograph that is prepared for healthcare professionals and includes this Patient Medication Information by visiting the Health Canada website (<https://www.canada.ca/en/health-canada/services/drugs-health-products/drug-products/drug-product-database.html>); the manufacturer's website (www.abbvie.ca), or by calling 1-888-704-8271.

This leaflet was prepared by AbbVie Corporation.

Last Revised: JAN 25, 2023

PATIENT MEDICATION INFORMATION

READ THIS FOR SAFE AND EFFECTIVE USE OF YOUR MEDICINE

PrSKYRIZI®

90 mg/mL risankizumab injection, solution for subcutaneous injection

Read this carefully before you start taking **Skyrizi** and each time you get a refill. This leaflet is a summary and will not tell you everything about this drug. Talk to your healthcare professional about your medical condition and treatment and ask if there is any new information about **Skyrizi**.

What is Skyrizi used for?

- Skyrizi is a prescription medicine used to treat adults with moderate to severe plaque psoriasis, an inflammatory condition affecting the skin and nails. Plaque psoriasis can cause raised, thick, red and scaly patches (“psoriatic lesions”) that can appear anywhere on your body.
- Skyrizi is used to treat adults with active psoriatic arthritis. Psoriatic arthritis is an inflammatory disease of the joints, usually accompanied by psoriasis. Psoriatic arthritis can cause pain, swelling and stiffness in the joints, in addition to a disruption in daily activities and fatigue. If you have active psoriatic arthritis, you will be given Skyrizi alone or in combination with a conventional Disease Modifying Anti-Rheumatic Drug (DMARD), such as methotrexate.

How does Skyrizi work?

Plaque Psoriasis

Skyrizi contains the active substance risankizumab. This medicine works by stopping a protein in the body called IL-23, which causes inflammation. It also improves skin clearance and reduces symptoms of psoriasis such as burning, itching, pain, and redness.

Psoriatic Arthritis

Skyrizi reduces the inflammation and can therefore help to reduce pain, stiffness, and swelling in and around your joints, pain and stiffness in your spine, psoriatic skin rash, psoriatic nail damage, and it may limit damage to the bone and cartilage in your joints. These effects can ease your normal daily activities, reduce tiredness, and improve your quality of life.

What are the ingredients in Skyrizi?

Medicinal ingredients: risankizumab

Non-medicinal ingredients: disodium succinate hexahydrate, polysorbate 20, sorbitol, succinic acid, and water for injection.

Skyrizi comes in the following dosage forms:

Pre-filled syringe with 75 mg of risankizumab in 0.83 mL of solution for injection (90 mg/mL).

Skyrizi is a clear and colourless to slightly yellow liquid in a pre-filled syringe with needle guard. Each carton contains 2 pre-filled syringes.

Do not use Skyrizi if:

- You have had a serious allergic reaction to risankizumab or any of the other ingredients of Skyrizi (See **What are the ingredients in Skyrizi?**). Symptoms of serious allergic reactions include: trouble breathing, feeling faint or dizzy, or swelling of your lips, tongue, or throat.
- If any of these symptoms occur during treatment with Skyrizi, stop taking Skyrizi and get emergency medical help right away.

To help avoid side effects and ensure proper use, talk to your healthcare professional before you take Skyrizi. Talk about any health conditions or problems you may have, including if you:

- currently have an infection or if you have an infection that keeps coming back. Skyrizi may lower your ability to fight infections and may increase your risk of infections.
- have tuberculosis (TB) or have been in close contact with someone with TB.
- have recently received or plan to receive an immunization (vaccine). You should not be given certain types of vaccines (called 'live vaccines') while using Skyrizi.

Talk to your healthcare professional right away if you have any of the symptoms of serious infection:

- fever, flu-like symptoms, night sweats
- feeling tired or short of breath
- cough
- blood in your phlegm (mucus)
- warm, red or painful skin, sores on your body different from your psoriasis, or a painful skin rash with blisters
- muscle aches
- weight loss

Talk to your healthcare professional right away if you have any of the symptoms of an allergic reaction, including:

- difficulty breathing or swallowing
- swelling of the face, lips, tongue or throat
- severe itching of the skin, with a red rash or raised bumps

Other warnings you should know about:

Skyrizi is not approved for children and adolescents under 18 years of age. This is because it has not been studied in this age group.

If you are pregnant, think you may be pregnant or are planning to have a baby, ask your doctor for advice before using this medicine. This is because it is not known if Skyrizi can harm your unborn baby. If you are a woman of childbearing potential, use adequate contraception while using Skyrizi and for at least 20 weeks after the last Skyrizi dose. Talk to your doctor about your contraception options.

If you are breastfeeding or are planning to breastfeed, talk to your doctor before using this medicine. It is not known if Skyrizi passes into breast milk. You and your doctor should decide if you will breastfeed while using Skyrizi.

Tell your healthcare professional about all the medicines you take, including any drugs, vitamins, minerals, natural supplements or alternative medicines.

How to take Skyrizi:

- Always use this medicine exactly as your doctor, pharmacist or nurse has told you. Check with your doctor, pharmacist or nurse if you are not sure how to use this medicine.
- Skyrizi is given as 2 injections under your skin (called “subcutaneous injections”).
- You and your doctor, pharmacist or nurse will decide if you should inject Skyrizi yourself. Do not inject yourself with this medicine unless you have been trained by your doctor, pharmacist or nurse. A caregiver may also give your injections after training. The AbbVie Care Support Program is also available to you if you require assistance with injections should you prefer nurse-administered injections. Information about the support services can be obtained by calling the AbbVie Care Support Program at 1-866-848-6472.
- **For a more comfortable injection:** Take the carton out of the refrigerator and leave it at room temperature, out of direct sunlight, for **15 to 30 minutes** before injecting.
- Read the “**Instructions for Use**” before injecting Skyrizi yourself.

Usual dose:

The dose is 150 mg given as two 75 mg injections.

	How much?	When?
1st dose	150 mg (two 75 mg injections)	When your doctor tells you
2nd dose	150 mg (two 75 mg injections)	4 weeks after 1 st dose
Further doses	150 mg (two 75 mg injections)	Every 12 weeks starting after 2 nd dose

Do not stop using Skyrizi without talking to your doctor first. If you stop treatment, your symptoms may come back.

Overdose:

If you think you, or a person you are caring for, have taken too much Skyrizi, contact your healthcare professional, hospital emergency department or regional poison control centre immediately, even if there are no symptoms.

Missed Dose:

If you forgot to use Skyrizi, inject a dose as soon as you remember. Then, take your next dose at your regular scheduled time. Talk to your doctor if you are not sure what to do.

What are possible side effects from using Skyrizi?

These are not all the possible side effects you may have when taking Skyrizi. If you experience any side effects not listed here, contact your doctor. Your doctor will decide if you can keep using Skyrizi.

Tell your doctor, pharmacist or nurse if you get any of the following side effects:

Very common: may affect more than 1 in 10 people

- upper respiratory infections with symptoms such as sore throat and stuffy nose

Common: may affect up to 1 in 10 people

- feeling tired
- fungal skin infection

- injection site reactions
- headache
- itching
- burning when you urinate or urinating more often than normal

Uncommon: may affect up to 1 in 100 people

- small raised red bumps on the skin

Serious side effects and what to do about them			
Symptom / effect	Talk to your healthcare professional		Stop taking drug and get immediate medical help
	Only if severe	In all cases	
UNCOMMON			
Serious Infections: Fever, flu-like symptoms, night sweats, cough, blood in your phlegm (mucus), warm, red or painful skin, muscle aches, weight loss		√	√

If you have a troublesome symptom or side effect that is not listed here or becomes bad enough to interfere with your daily activities, talk to your doctor, pharmacist or nurse.

Reporting Side Effects

You can report any suspected side effects associated with the use of health products to Health Canada by:

- Visiting the Web page on Adverse Reaction Reporting (<https://www.canada.ca/en/health-canada/services/drugs-health-products/medeffect-canada.html>) for information on how to report online, by mail or by fax; or
- Calling toll-free at 1-866-234-2345.

NOTE: Contact your health professional if you need information about how to manage your side effects. The Canada Vigilance Program does not provide medical advice.

Storage:

Keep this medicine out of reach and sight of children.

Do not use this medicine after the expiration date which is stated on the syringe label and outer carton after 'EXP'.

Store in a refrigerator between 2 and 8 °C (36 and 46 °F). Do not freeze. Do not use if Skyrizi has been frozen.

Keep the pre-filled syringes in the original carton in order to protect from light.

The liquid should look clear to slightly yellow. The liquid may contain tiny white or clear particles. Do not use if liquid is cloudy or contains flakes or large particles.

This medicine is for single use only. Ask your doctor, pharmacist or nurse how to throw away used syringes safely.

If you want more information about Skyrizi:

- Talk to your healthcare professional.
- Find the full product monograph that is prepared for healthcare professionals and includes this Patient Medication Information by visiting the Health Canada website: <https://www.canada.ca/en/health-canada/services/drugs-health-products/drug-products/drug-product-database.html>; the manufacturer's website (www.abbvie.ca), or by calling 1-888-704-8271.

This leaflet was prepared by AbbVie Corporation.

Last Revised: JAN 25, 2023

Instructions for Use
Skyrizi®
(risankizumab injection)
150 mg in 1 mL sterile solution (150 mg/mL) subcutaneous injection
Pre-filled pen

Please read complete instructions before using Skyrizi.

Skyrizi pre-filled pen

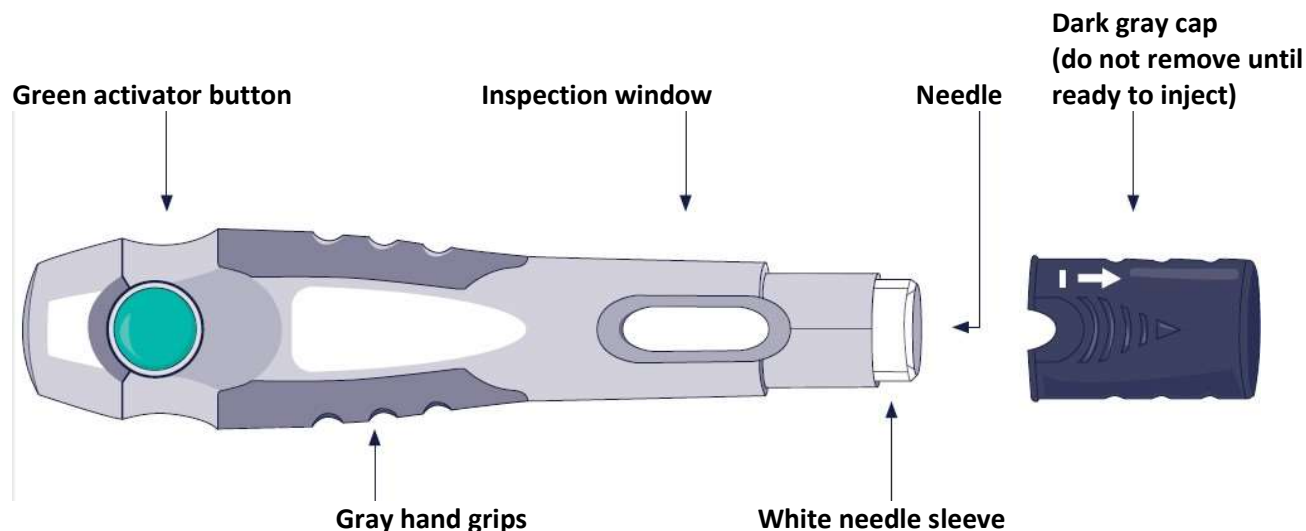

Important information to know before you inject Skyrizi

- Receive training on how to inject Skyrizi before giving an injection. Talk to your doctor, pharmacist or nurse if you need help. The AbbVie Care Support Program is also available to you if you have questions regarding the injection process. Information about the support services can be obtained by calling the AbbVie Care Support Program at 1-866-848-6472.
- Mark the dates on your calendar so you know when to next use Skyrizi.
- Keep Skyrizi in the original carton to protect from light until it is time to use it.
- Take the carton out of the refrigerator and leave it at room temperature, out of direct sunlight, for **30 to 90 minutes** before injecting.
- **Do not** inject if the liquid in the inspection window is cloudy or contains flakes or large particles. The liquid should look clear to yellow and may contain tiny white or clear particles.
- **Do not** use if expiration date (EXP) has passed.
- **Do not** use if liquid has been frozen (even if thawed).
- **Do not** shake the pen.
- **Do not** use if pen has been dropped or damaged.
- **Do not** use if the carton perforations are broken. Return this medicine to the pharmacy.
- **Do not** remove the dark gray cap until just before the injection.

Storage Information

Store in refrigerator between 2 and 8 °C (36 and 46 °F). Do not freeze. Keep Skyrizi out of reach and sight of children. Keep Skyrizi pre-filled pen in the original carton to protect from light.

Skyrizi 150 mg/mL pre-filled pen may be stored out of the refrigerator (up to a maximum of 25°C [77°F]) for up to 24 hours in the original carton to protect from light.

Follow the steps below each time you use Skyrizi

Prepare for Injection

STEP 1



Take the carton out of the refrigerator and leave it at room temperature, out of direct sunlight, for **30 to 90 minutes** before injecting.

- **Do not** remove the pen from the carton while allowing Skyrizi to reach room temperature.
- **Do not** warm Skyrizi in any other way. For example, do not warm it in a microwave or in hot water.
- **Do not** use the pen if liquid has been frozen, even if it has been thawed.

STEP 2

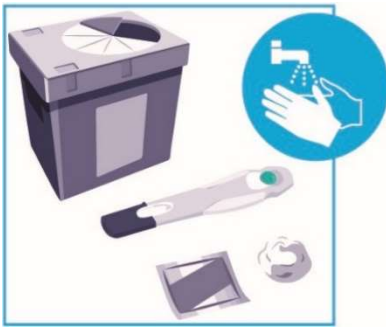

You will need these supplies:

- 1 pre-filled pen

Not provided in the Skyrizi carton:

- 1 alcohol pad
- 1 cotton ball or gauze pad
- special disposal container

Place these items on a clean, flat surface.

Wash and dry your hands.

STEP 3

Areas to inject

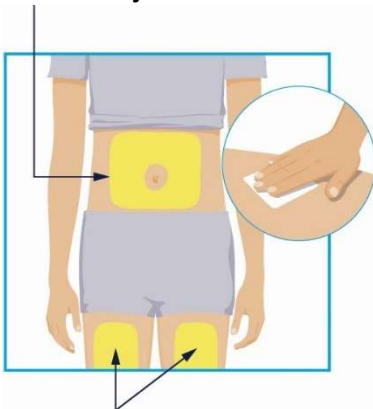

Areas to inject

Choose from these 3 areas to inject:

- front of left thigh or right thigh
- belly (abdomen) at least 5 cm (2 inches) from the belly button (navel)

Before the injection, wipe where you will inject in a circular motion with an alcohol pad.

- **Do not** touch or blow on the injection site after it is cleaned. Allow the skin to dry before injecting.
- **Do not** inject through clothes.
- **Do not** inject into skin that is sore, bruised, red, hard, scarred, or has stretch marks.
- **Do not** inject into areas affected by psoriasis.

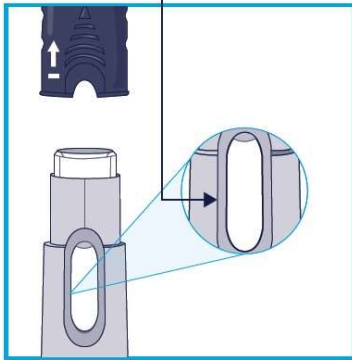
STEP 4**Check liquid**

Hold the pen with the dark gray cap pointing up, as shown.

- Pull the dark gray cap straight off.
- Throw the dark gray cap away.

Check the liquid through the inspection window.

- It is normal to see bubbles in the liquid.
- The liquid should look clear to yellow and may contain tiny white or clear particles.
- **Do not** use if the liquid is cloudy or contains flakes or large particles.

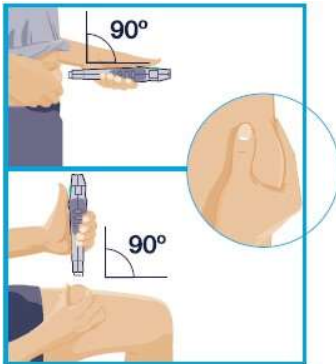
STEP 5**Abdomen or Thigh**

- Hold the pen with your fingers on the gray hand grips.
- Turn the pen so that the white needle sleeve points toward the injection site and you can see the green activator button.
- Gently squeeze the skin at your injection site to make a raised area and hold it firmly.
- Place the white needle sleeve straight (90° angle) against the raised injection site.

Inject Skyrizi**STEP 6****First “click” 15 seconds**

Hold the pen so that you can see the green activator button and inspection window.

Push and keep pressing the pen down against the raised injection site.

- The pen will activate only if the white needle sleeve is pressed down against the injection site before pressing the green activator button.

Press the green activator button and hold the pen for **15** seconds.

- A loud “click” means the start of the injection.

STEP 7

Second “click”

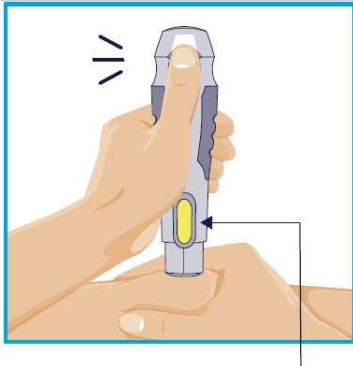

Yellow indicator

Keep pressing the pen down against the injection site.

The injection is complete when:

- the pen has made a second “click” or
- the yellow indicator has filled the inspection window.

This takes **up to 15** seconds.

STEP 8

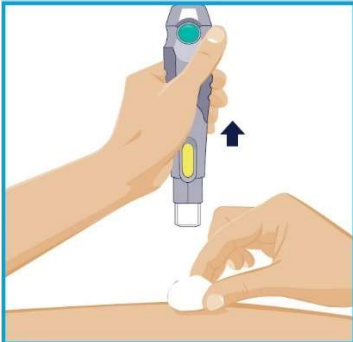

When the injection is complete, slowly pull the pen out from the skin.

The white needle sleeve will cover the needle tip and make another “click.”

After completing the injection, place a cotton ball or gauze pad on the skin at the injection site.

- **Do not** rub the injection site.
- Slight bleeding at the injection site is normal.

After your Injection

STEP 9



Throw away the used pen in a special disposal container right away after use.

- **Do not** throw away the used pen in the household waste.
- Your doctor, pharmacist or nurse will tell you how to return the full special disposal container.

Need Help?

Call your doctor to talk about any questions you may have. For questions or concerns visit the manufacturer’s website (www.abbvie.ca) or call 1-888-704-8271.

This leaflet was prepared by AbbVie Corporation.

Last Revised: JAN 25, 2023

Instructions for Use
Skyrizi®
(risankizumab injection)
150 mg in 1 mL sterile solution (150 mg/mL) subcutaneous injection
Pre-filled syringe

Please read complete instructions before using Skyrizi.

Skyrizi pre-filled syringe

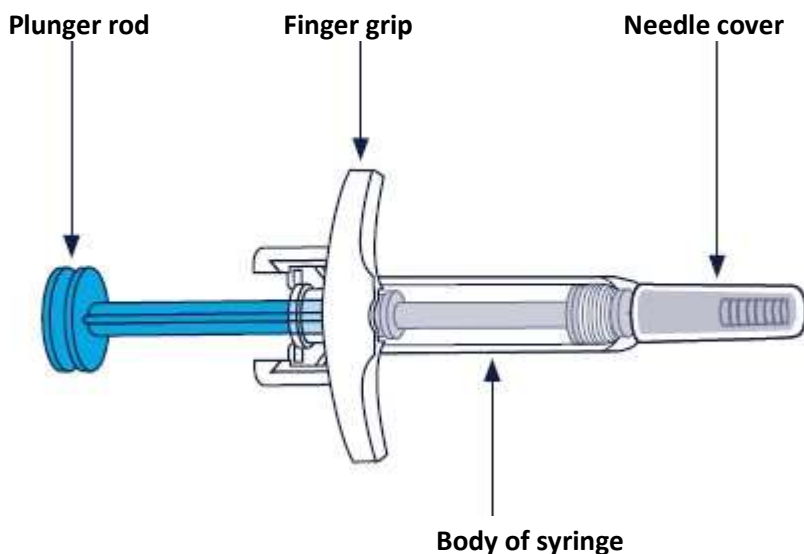

Important information to know before you inject Skyrizi

- If your doctor decides that you or a caregiver may be able to give your injections at home, you and your caregiver should receive training on how to inject Skyrizi before giving an injection. Injections should be given in the thighs or abdomen. Caregivers can also give Skyrizi in the upper outer arm. Talk to your doctor, pharmacist or nurse if you need help. The AbbVie Care Support Program is also available to you if you require assistance with injections should you prefer nurse-administered injections. Information about the support services can be obtained by calling the AbbVie Care Support Program at 1-866-848-6472.
- Mark the dates on your calendar so you know when to next use Skyrizi.
- Keep Skyrizi in the original carton to protect from light until it is time to use it.
- **Do not** inject if the liquid is cloudy or contains flakes or large particles. The liquid should look clear to yellow and may contain tiny white or clear particles.
- **Do not** use if the expiry date (EXP) has passed.
- **Do not** use if the liquid has been frozen (even if thawed).
- **Do not** shake the syringe.
- **Do not** use if the syringe has been dropped or damaged.
- **Do not** use if the carton perforations are broken. Return this medicine to the pharmacy.
- **Do not** remove the needle cover until just before the injection.

For a more comfortable injection: Take the carton out of the refrigerator and leave it at room temperature, out of direct sunlight, for **15 to 30 minutes** before injecting.

- **Do not** remove the syringe from the carton until ready to inject.
- **Do not** warm Skyrizi in any other way. For example, **do not** warm it in a microwave or in hot water.

Storage Information

Store in refrigerator between 2 and 8 °C (36 and 46 °F). Do not freeze. Keep Skyrizi out of reach and sight of children. Keep Skyrizi pre-filled syringe in the original carton to protect from light.

Skyrizi 150 mg/mL pre-filled syringe may be stored out of the refrigerator (up to a maximum of 25°C [77°F]) for up to 24 hours in the original carton to protect from light.

Follow the steps below each time you use Skyrizi

Prepare for Injection

STEP 1



You will need these supplies:

- 1 pre-filled syringe – remove it from the cardboard sleeve by holding the finger grip. **Do not** hold or pull plunger rod when removing the pre-filled syringe from the sleeve.

Not provided in the Skyrizi carton:

- 1 alcohol pad
- 1 cotton ball or gauze pad
- special disposal container

Place these items on a clean, flat surface.
Wash and dry your hands.

STEP 2

Areas to inject

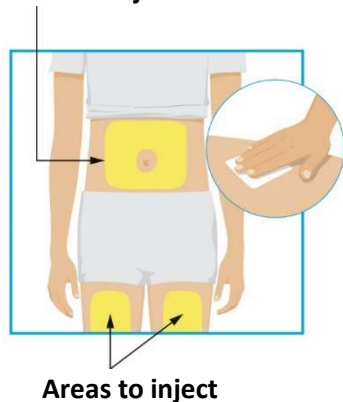

Choose from these 3 areas to inject:

- front of left thigh or right thigh
- belly (abdomen) at least 5 cm (2 inches) from the belly button (navel)

Before the injection, wipe where you will inject in a circular motion with an alcohol pad.

- **Do not** touch or blow on the injection site after it is cleaned. Allow the skin to dry before injecting.
- **Do not** inject through clothes.
- **Do not** inject into skin that is sore, bruised, red, hard, scarred, or has stretch marks.
- **Do not** inject into areas affected by psoriasis.

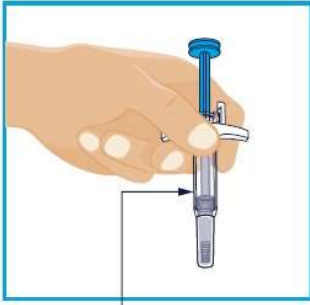
STEP 3

Check liquid

Hold the syringe with covered needle pointing down, as shown.

Check the liquid in the syringe.

- It is normal to see bubbles in the window.
- The liquid should look clear to yellow and may contain tiny white or clear particles.
- **Do not** use if the liquid is cloudy or contains flakes or large particles.

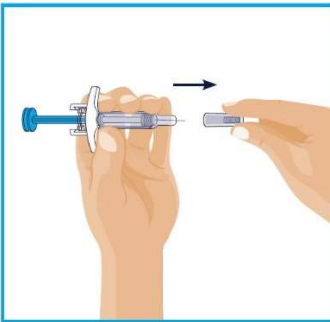
STEP 4

Removing the needle cover:

- Hold the syringe in one hand between the finger grip and needle cover.
- With the other hand, gently pull the needle cover straight off.
- **Do not** hold or pull plunger rod when removing the needle cover.
- You may see a drop of liquid at the end of the needle. This is normal.
- Throw away the needle cover.
- **Do not** touch the needle with your fingers or let the needle touch anything.

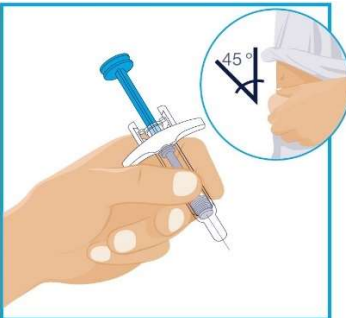
Inject Skyrizi**STEP 5**

Hold the body of the syringe in one hand between the thumb and index finger, like you would a pencil.

Gently pinch the area of cleaned skin with your other hand and hold it firmly.

Insert the needle all the way into the skin at about a 45-degree angle using a quick, short movement. Keep the syringe steady at the same angle.

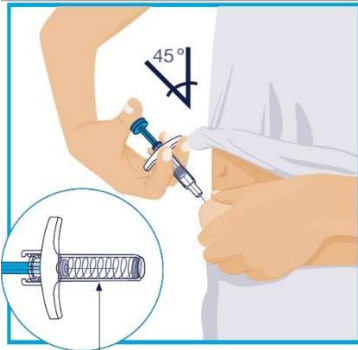
STEP 6**Needle guard**

Slowly push the plunger rod all the way in until all of the liquid is injected.

Pull the needle out of the skin while keeping the syringe at the same angle.

Slowly take your thumb off the plunger rod. The needle will then be covered by the needle guard.

- The needle guard will not activate unless all the liquid is injected.
- Speak to your doctor, pharmacist or nurse if you think you have not given a full dose.

Press a cotton ball or gauze pad where you have injected and hold for 10 seconds.

Do not rub the skin where you have injected. You may have slight bleeding from where you injected. This is normal.

After injection**STEP 7**

Throw away the used syringe in a special disposal container right away after use.

- **Do not** throw away the used syringe in the household waste.
- Your doctor, pharmacist or nurse will tell you how to return the full special disposal container.

Need Help?

Call your doctor to talk about any questions you may have. For questions or concerns visit the manufacturer's website (www.abbvie.ca) or call 1-888-704-8271.

This leaflet was prepared by AbbVie Corporation.

Last Revised: JAN 25, 2023

Instructions for Use Skyrizi®

(risankizumab injection)

360 mg in 2.4 mL sterile solution (150 mg/mL) for subcutaneous injection

On-body injector with pre-filled cartridge

Please read complete instructions before using Skyrizi.

Important information to know before you inject Skyrizi

- Receive training on how to inject Skyrizi before giving an injection. Talk to your doctor, pharmacist or nurse if you need help. The AbbVie Care Support Program is also available to you if you have questions regarding the injection process. Information about the support services can be obtained by calling the AbbVie Care Support Program at 1-866-848-6472.
- Mark the dates on your calendar so you know when to next use Skyrizi.
- **Do not** shake the Skyrizi carton, on-body injector or pre-filled cartridge.
- **Do not** reuse on-body injector or pre-filled cartridge. The on-body injector and pre-filled cartridge are for 1-time (single-dose) use only. This single-dose on-body injector is designed for use with Skyrizi pre-filled cartridge only.
- **Do not** let the on-body injector get wet with water or any other liquids.
- Physical activity should be limited during the injection process. Moderate physical activities can be done, such as walking, reaching and bending.
- The on-body injector and the pre-filled cartridge are not made with natural rubber latex.

Storage Information

- Store in refrigerator between 2 and 8 °C (36 and 46 °F). Do not freeze. Keep Skyrizi out of reach and sight of children. Keep Skyrizi in the original carton to protect from light and physical damage until time to use.

Get to know your Skyrizi on-body injector and pre-filled cartridge

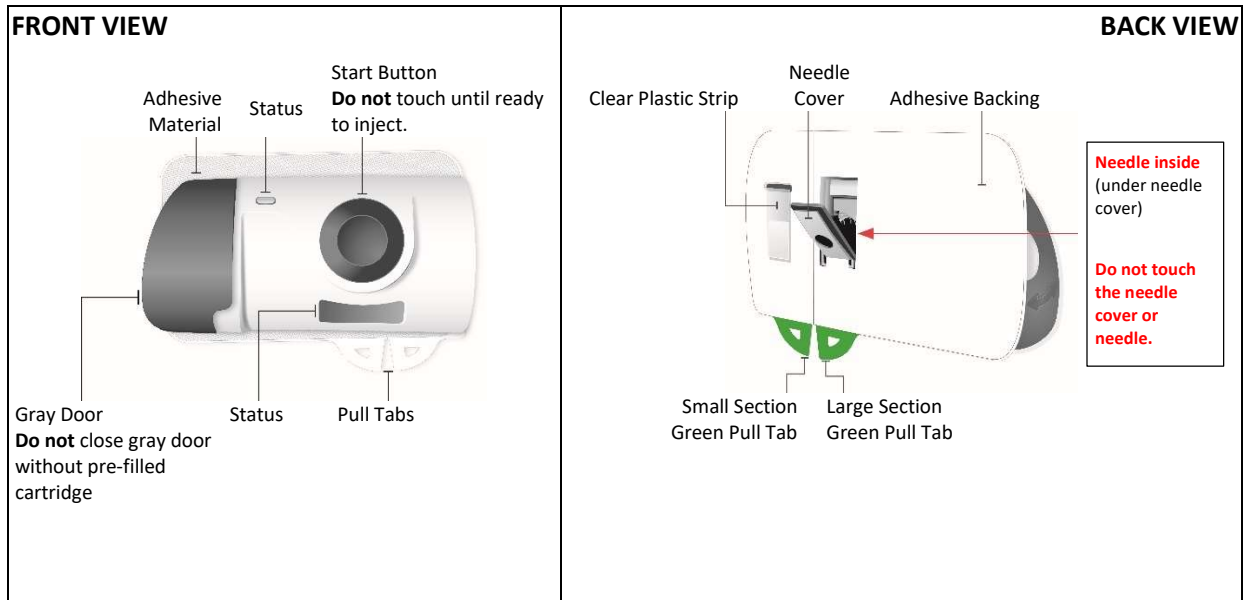

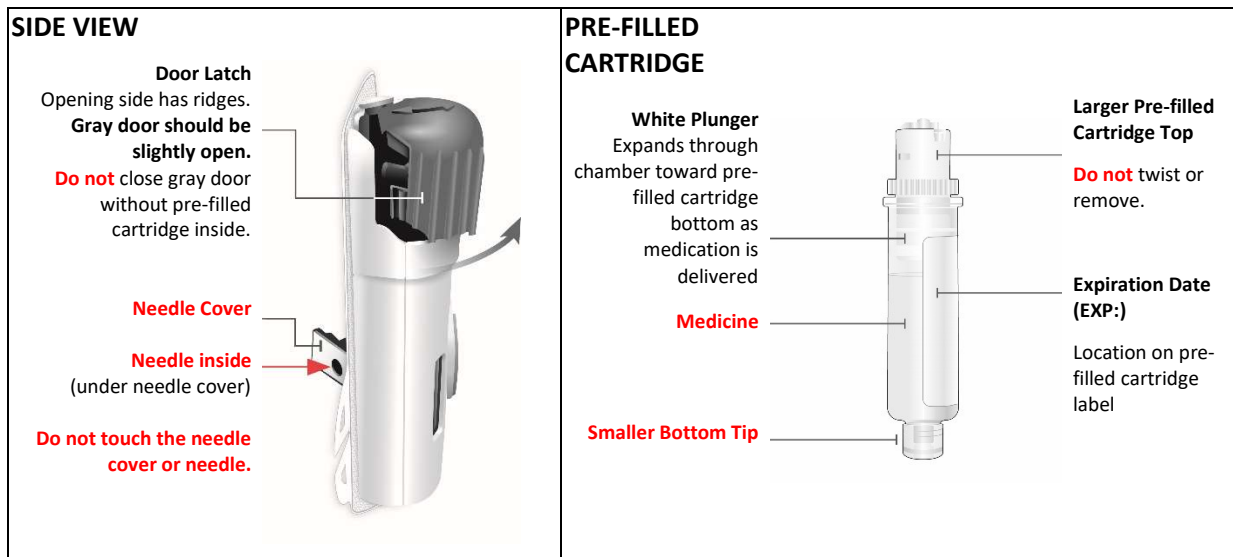

Follow the steps below each time you use Skyrizi

Prepare for Injection

STEP 1 – Get Ready

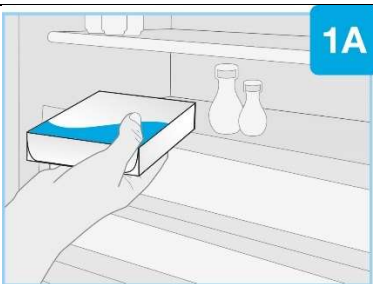

Take the carton out of the refrigerator and leave it at room temperature, out of direct sunlight, for **45 to 90 minutes** before injecting.

Check expiration date (EXP) on the carton. Do not use Skyrizi if the expiration date (EXP) has passed.

Do not remove the cartridge or on-body injector from the carton while allowing Skyrizi to reach room temperature.

Do not warm Skyrizi in any other way. For example, do not warm it in a microwave or in hot water.

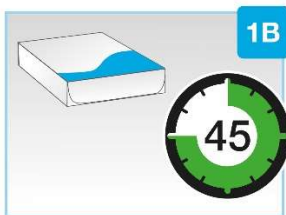

Wait at least 45 minutes.

Open the carton and remove the plastic tray.

Lift up the flap on the side of the carton.

Take out the plastic tray.

Sharps Container



Gather all supplies and wash your hands

You will need these supplies:

- Plastic tray containing 1 on-body injector and 1 pre-filled cartridge

Not provided in the Skyrizi carton:

- alcohol pads
- 1 cotton ball or gauze pad
- special disposal container

Place these items on a clean, flat surface.

Wash and dry your hands.

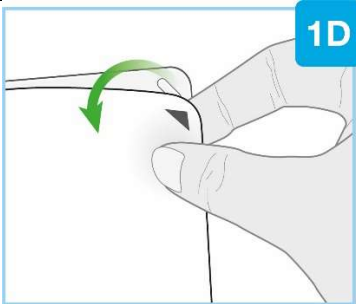

Remove the white paper tray seal

Locate the black arrow.

Peel away the white paper tray seal from the plastic tray.

Do not use the on-body injector and pre-filled cartridge if the white paper tray seal is missing or damaged and return the carton to the pharmacy.

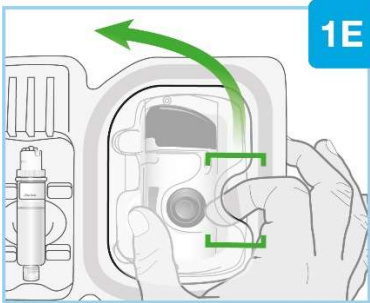

Lift the plastic cover

Locate the rounded opening on the top cover.

Insert your index finger in the opening and place your thumb on the opposite side.

Lift the cover to remove and set aside.

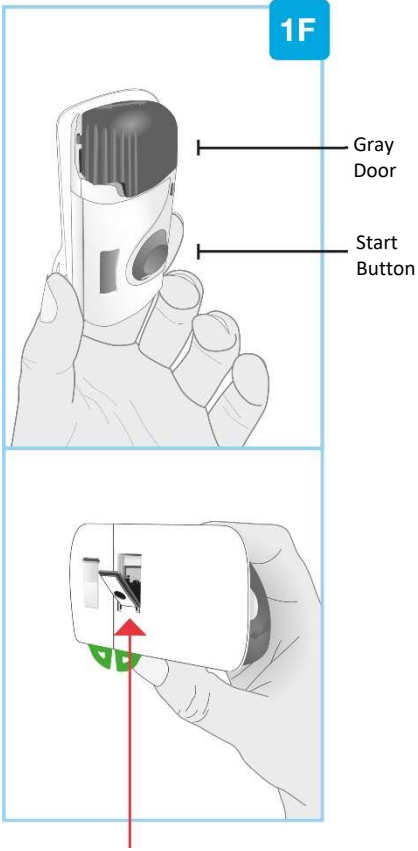

Needle inside
(under needle cover)

Inspect the on-body injector

Check that the on-body injector is intact and undamaged.

The gray door should be slightly open.

If the gray door does not open, press in firmly on the gray door ridges (left side of door) and swing open the door.

Do not close the gray door before the pre-filled cartridge is loaded.

Do not use on-body injector if you drop it, discover missing pieces, or it is damaged.

Do not touch the gray start button until it is time to inject. It can be pressed **1** time only.

If the gray start button is pressed before placing it on your body, the on-body injector can no longer be used. If this happens, speak to your doctor, pharmacist or nurse.

Do not touch the needle cover or the needle.

Proceed to Set up on-body injector.

STEP 2 - Set up on-body injector

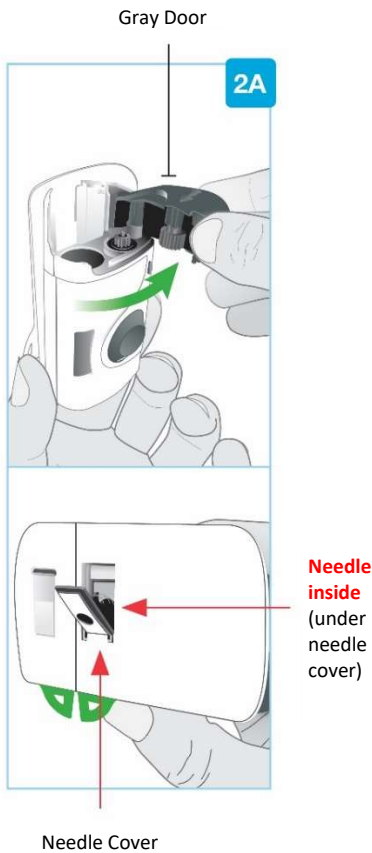

Fully open the grey door:

Avoid touching the needle cover area on the back of the on-body injector. The needle is behind the needle cover.

Swing the grey door all the way to the right to open it.

If the grey door does not open, press in firmly on the grey door ridges (left side of door) and swing open the door.

Do not close the grey door before the pre-filled cartridge is loaded.

Put the on-body injector aside on a clean surface.



Inspect the pre-filled cartridge

Carefully remove the pre-filled cartridge from the plastic tray.

Do not twist or remove cartridge top.

Check the pre-filled cartridge:

- The liquid should look clear to yellow and may contain tiny white or clear particles. It is normal to see one or more bubbles.
- **Do not** use if the liquid is cloudy, discoloured, or contains flakes or large particles.
- The pre-filled cartridge parts and the clear plastic are not cracked or broken.

Do not use if the liquid has been frozen (even if thawed).

Do not use the pre-filled cartridge if you drop it, discover missing pieces, or it is damaged.

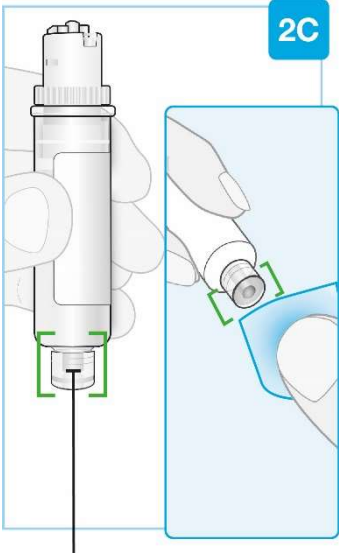

Smaller Bottom Tip Clean center of smaller bottom tip

2C

Clean the smaller bottom tip of the pre-filled cartridge

Locate the smaller bottom tip of the pre-filled cartridge.

Clean smaller bottom tip of the pre-filled cartridge with an alcohol pad. Make sure to use the alcohol pad to clean the center of the smaller bottom tip of the pre-filled cartridge.

Do not touch the smaller bottom tip of the pre-filled cartridge after cleaning.

Insert straight

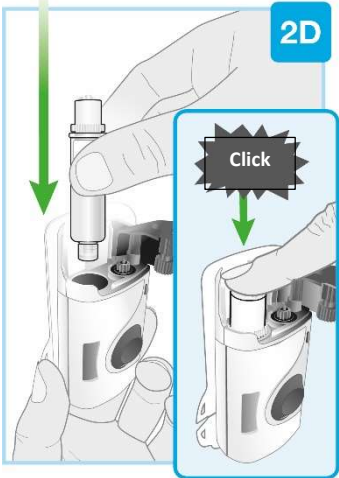

2D

Load the cleaned pre-filled cartridge into the on-body injector

Do not twist or remove the pre-filled cartridge top.

Insert the smaller bottom tip of the pre-filled cartridge into the on-body injector first.

Firmly push down on the pre-filled cartridge top until you hear a "click".

After loading the pre-filled cartridge, you may see a few drops of medicine on the back of the on-body injector. This is normal.

Make sure to proceed to the next step without delay. Waiting will dry out the medicine and the on-body injector will not work afterwards.



2E

Close the grey door:

Swing the grey door to the left, then squeeze firmly and listen for the grey door to "snap" shut.

The grey door should stay locked after loading the pre-filled cartridge.

Do not close the grey door if the pre-filled cartridge is not fully inserted or is missing.

Proceed without delay to the next step.

STEP 3 - Prepare to inject

Areas to inject

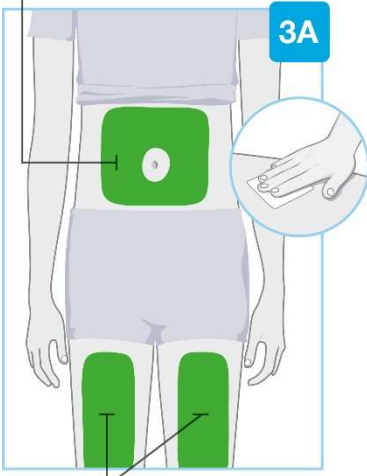

Areas to inject

Pick your injection area

Choose from these 3 areas to inject:

- front of left thigh or right thigh
- belly (abdomen) at least 5 cm (2 inches) from the belly button (navel)

Do not inject into areas of the skin that naturally fold or bulge because the on-body injector could fall off during wear.

Do not inject into skin that is sore, bruised, red, hard, scarred, or has stretch marks, moles or excessive hair. You can trim the excessive hair from the injection area.

Do not inject through clothes.

Before the injection, wipe where you will inject in a circular motion with an alcohol pad.

Do not touch or blow on the injection site after it is cleaned. Allow the skin to dry before placing the on-body injector on the body.

Small Section Large Section

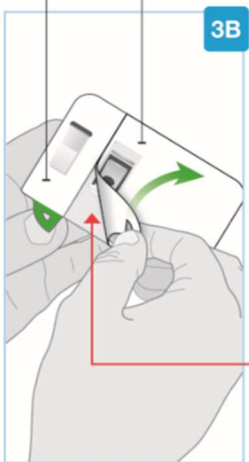

Needle inside
(under cover
needle)

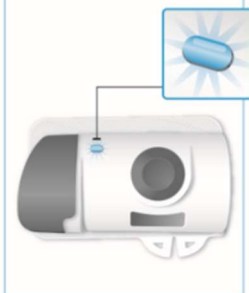

Status light
flashing blue

Peel both tabs to expose skin adhesive

Turn the on-body injector over to find both green pull tabs.

Avoid touching the needle cover (needle inside).

Peel away the **large section** using the green pull tab to expose the skin adhesive.

Peel away the **small section** using the green pull tab to expose the skin adhesive. This will remove the clear plastic strip, activating the on-body injector.

Check the status light when the on-body injector beeps.

The status light will flash blue when the on-body injector is activated.

If the status light does not flash blue, speak to your doctor, pharmacist, nurse or AbbVie Care Support Program.

Do not press the grey start button yet.

Do not touch the needle cover or the needle.

Do not pull the adhesive material off on-body injector or allow the sticky side to fold and stick to itself.

The Skyrizi on-body injector must be placed on the skin and injection must be started within 30 minutes after removing

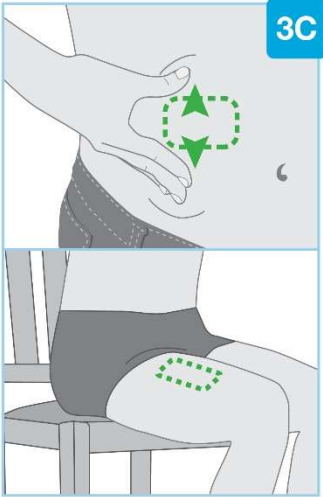
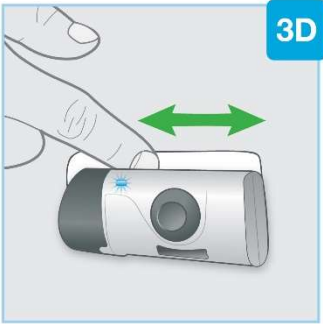
	<p>the green pull tabs or it will not work. Make sure to proceed to next step without delay.</p>
	<p>If the status light flashes red, the on-body injector is not working properly. Do not continue to use it.</p> <p>Speak to your doctor, pharmacist, nurse or AbbVie Care Support Program for assistance.</p> <p>If on-body injector is attached to your body, carefully remove from your skin.</p>
	<p>Prepare the on-body injector for placement</p> <p>For the belly, move and hold the skin to create a firm, flat surface for injection at least 5 cm from your belly button (navel). Make sure to sit up straight to avoid skin folds and bulges.</p> <p>You do not need to pull the skin flat for the front of left thigh or right thigh.</p> <p>Make sure to place the on-body injector so that you can see the blue status light.</p>
	<p>Place the on-body injector on your skin</p> <p>When the blue light flashes, the on-body injector is ready. Place the on-body injector onto the cleaned skin with the status light visible.</p> <p>Do not place the on-body injector on clothes. Only place on bare skin.</p> <p>Run your finger around the adhesive material to secure it.</p> <p>Do not move or adjust the on-body injector after it has been placed on your skin.</p> <p>Proceed without delay to the next step.</p>

STEP 4 - Inject Skyrizi

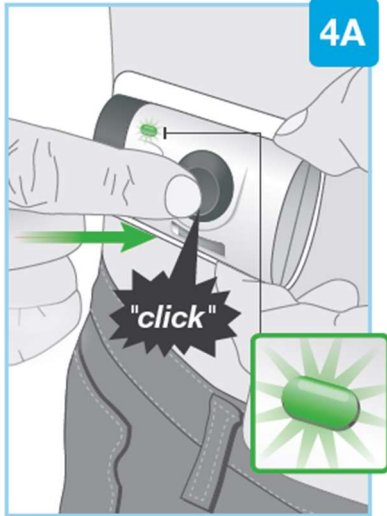

Start injection

Firmly press and release the grey start button.

- You will hear a "click" and may feel a needle pinch.
- Check the status light when the on-body injector beeps.
- After starting the injection, the status light will continuously flash green.
- After starting the injection, you will hear pumping sounds as the on-body injector delivers the medicine.

Do not continue to use the on-body injector if status light flashes red. Carefully remove from skin if the status light flashes red. If this happens, speak to your doctor, pharmacist, nurse, or AbbVie Care Support Program.

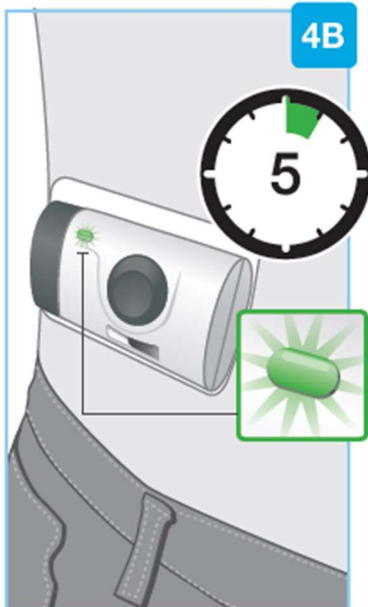

Wait for the injection to finish

- It may take up to 5 minutes to complete the full dose of medicine. The on-body injector will automatically stop when the injection is finished.
- During the injection, the status light will continue to flash green.
- During the injection, you will hear pumping sounds as the on-body injector continues delivering the medicine.
- During the injection, moderate physical activities can be done, such as walking, reaching and bending.

Do not continue to use the on-body injector if the status light flashes red. Carefully remove it from the skin if the status light flashes red. If this happens, speak to your doctor, pharmacist, nurse, or AbbVie Care Support Program.

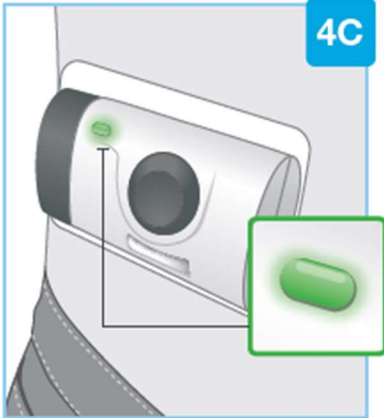

Injection is complete when:

- the on-body injector stops on its own
- you hear a beep and the status light changes to solid green. If the status light has changed to solid green, this means that the injection is complete.

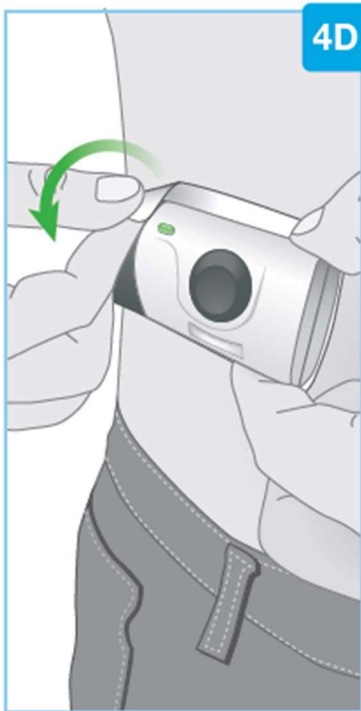

Remove the on-body injector:

Do not put your fingers on the back side of the on-body injector when removing it from your skin.

When the injection is done, grab the corner of the adhesive to carefully peel the on-body injector from the skin.

Avoid touching the needle cover or needle on the back of the on-body injector.

After removing the on-body injector, you will hear several beeps and the status light will turn off.

The needle cover will cover the needle when the on-body injector is removed from the skin.

It is normal to see a few small drops of liquid on your skin after removing the on-body injector.

Press a cotton ball or gauze pad over the injection site on your skin and hold for 10 seconds.

Do not rub the injection site.

Slight bleeding at the injection site is normal.

Proceed to the next step.

Step 5 - After your Injection

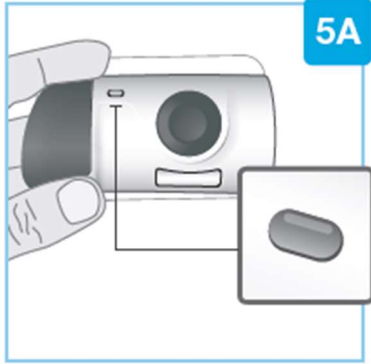

Check the on-body injector

Inspect the medicine window and status light.

Check to see that the white plunger fills the entire medicine window and the solid green light turns off, letting you know that all the medicine has been injected.





- If the white plunger does not fill the window, speak to your doctor, pharmacist or nurse.



Disposal

Throw away the used on-body injector in a special disposal container straight after use.

- The on-body injector contains batteries, electronics, and a needle.
- Leave the pre-filled cartridge in the on-body injector.
- **Do not** throw away the used on-body injector in the household waste.
- Your doctor, pharmacist, nurse, or AbbVie Care Support Program will tell you how to return the full special disposal container. There may be local guidelines for disposal.

Symbol Key		
	Flashing blue light	On/ Ready
	Flashing green light	Injection has started
	Solid green light	Injection has finished
	No light	Off/ Finished
	Flashing red light	Do not continue to use the on-body injector. It is not working properly. Call AbbVie Care Support Program at 1-866-848-6472 for more information.

Need Help?

Call your doctor to talk about any questions you may have. For questions or concerns visit the manufacturer's website (www.abbvie.ca) or call 1-888-704-8271.

This leaflet was prepared by AbbVie Corporation.

Last Revised: JAN 25, 2023

Instructions for Use
Skyrizi®
(risankizumab injection)
75 mg in 0.83 mL sterile solution (90 mg/mL) subcutaneous injection
Pre-filled syringe

Please read complete instructions before using Skyrizi.

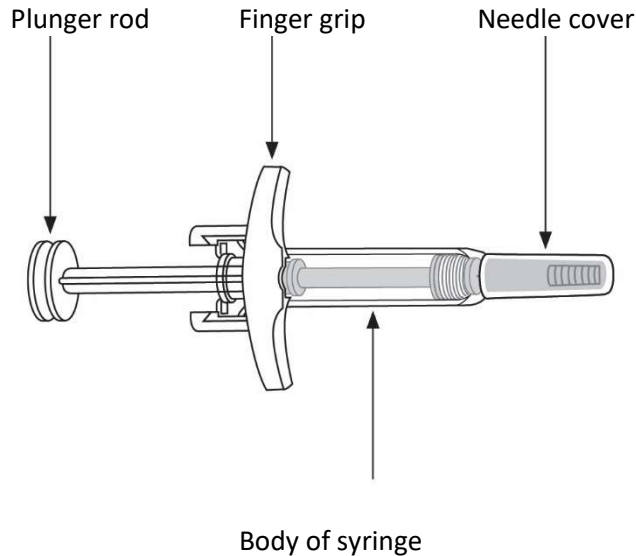

Important information to know before you inject Skyrizi

- If your doctor decides that you or a caregiver may be able to give your injections at home, you and your caregiver should receive training on how to inject Skyrizi before giving an injection. Injections should be given in the thighs or abdomen. Caregivers can also give Skyrizi in the upper outer arm. Talk to your doctor, pharmacist or nurse if you need help. The AbbVie Care Support Program is also available to you if you require assistance with injections should you prefer nurse-administered injections. Information about the support services can be obtained by calling the AbbVie Care Support Program at 1-866-848-6472.
- Mark the dates on your calendar so you know when to next use Skyrizi.
- Keep Skyrizi in the original carton to protect from light until it is time to use it.
- **Do not** inject if the liquid is cloudy or contains flakes or large particles. The liquid should look clear to slightly yellow and may contain tiny white or clear particles.
- **Do not** use if the expiry date (EXP) has passed.
- **Do not** use if the liquid has been frozen (even if thawed).
- **Do not** shake the syringe.
- **Do not** use if the syringe has been dropped or damaged.
- **Do not** use if the syringe tray cover is broken or missing. Return this medicine to the pharmacy.
- **Do not** remove the needle cover until just before the injection.

For a more comfortable injection: Take the carton out of the refrigerator and leave it at room temperature, out of direct sunlight, for **15 to 30 minutes** before injecting.

- **Do not** remove the syringes from the carton until ready to inject.
- **Do not** warm Skyrizi in any other way. For example, **do not** warm it in a microwave or in hot water.

Storage Information

Store in refrigerator between 2 and 8 °C (36 and 46 °F). Do not freeze. Keep Skyrizi out of reach and sight of children. Keep Skyrizi pre-filled syringe in the original carton to protect from light.

Follow the steps below each time you use Skyrizi

Prepare for Injection

STEP 1



You will need these supplies:

- 2 pre-filled syringes

Not provided in the Skyrizi carton:

- 2 alcohol pads
- 2 cotton balls or gauze pads
- Special disposal container

Place these items on a clean, flat surface.

Wash and dry your hands.

Start with one syringe for the first injection.

For a full dose, 2 injections are required, one after the other.

STEP 2

Areas to inject

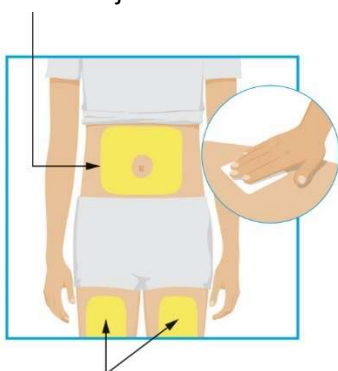

Areas to inject

Choose from these 3 areas to inject:

- front of left thigh or right thigh
- belly (abdomen) at least 5 cm (2 inches) from the belly button (navel)

For the second syringe, inject at least 3 cm (1 inch) away from the first injection. **Do not** inject into the same place.

Before each injection, wipe where you will inject in a circular motion with an alcohol pad.

- **Do not** touch or blow on the injection site after it is cleaned. Allow the skin to dry before injecting.
- **Do not** inject through clothes.
- **Do not** inject into skin that is sore, bruised, red, hard, scarred, or has stretch marks.
- **Do not** inject into areas affected by psoriasis.

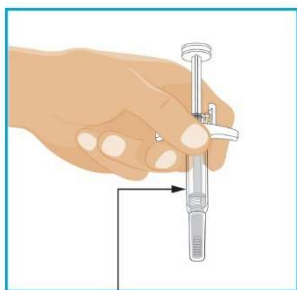
STEP 3

Check liquid

Hold the syringe with covered needle pointing down, as shown. Check the liquid in the syringe.

- It is normal to see bubbles in the window.
- The liquid should look clear to slightly yellow and may contain tiny white or clear particles.
- **Do not** use if the liquid is cloudy or contains flakes or large particles.

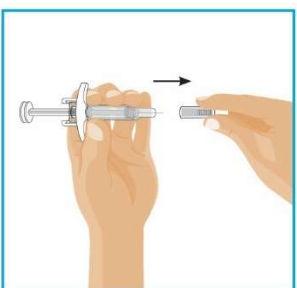
STEP 4

Removing the needle cover:

- Hold the syringe in one hand between the finger grip and needle cover.
- With the other hand, gently pull the needle cover straight off.
- **Do not** hold or pull plunger rod when removing the needle cover.
- You may see a drop of liquid at the end of the needle. This is normal.
- Throw away the needle cover.
- **Do not** touch the needle with your fingers or let the needle touch anything.

Inject Skyrizi**STEP 5**

Hold the body of the syringe in one hand between the thumb and index finger, like you would a pencil.

Gently pinch the area of cleaned skin with your other hand and hold it firmly.

Insert the needle all the way into the skin at about a 45-degree angle using a quick, short movement. Keep the syringe steady at the same angle.

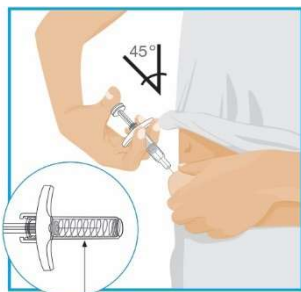
STEP 6

Needle guard

Slowly push the plunger rod all the way in until all of the liquid is injected.

Pull the needle out of the skin while keeping the syringe at the same angle.

Slowly take your thumb off the plunger rod. The needle will then be covered by the needle guard.

- The needle guard will not activate unless all the liquid is injected.
- Speak to your doctor, pharmacist or nurse if you think you have not given a full dose.

Press a cotton ball or gauze pad where you have injected and hold for 10 seconds.

Do not rub the skin where you have injected. You may have slight bleeding from where you injected. This is normal.

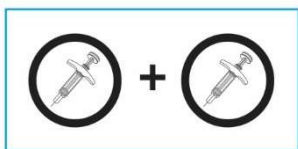
STEP 7

For a full dose, two injections are needed, one after the other.

- Repeat Steps 2 through 6 with the second syringe.
- Inject the second syringe immediately after the first injection, at least 3 cm away from the first injection.

After your Injection**STEP 8**

Throw away used syringes in a special disposal container right away after use.

- **Do not** throw away used syringes in the household waste.
- Your doctor, pharmacist or nurse will tell you how to return the full special disposal container.

Need Help?

Call your doctor to talk about any questions you may have. For questions or concerns visit the manufacturer's website (www.abbvie.ca) or call 1-888-704-8271.

This leaflet was prepared by AbbVie Corporation.

Last Revised: JAN 25, 2023